

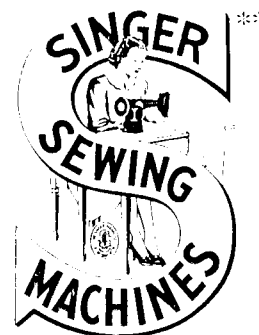
Form 20121  
(148)

Printed in U. S. A.

HISTORICAL COPY

DO NOT REMOVE

# LIST OF PARTS



MACHINES  
Nos. 55-3, 55-4, 55-5  
and 55-6

\*\*\* REG. U. S. PAT. OFF. BY

THE SINGER MANUFACTURING COMPANY

From the library of: Diamond Needle Corp

## INSTRUCTIONS FOR OILING

---

To ensure easy running and prevent unnecessary wear of the parts which are in movable contact, the machine requires oiling and when in continuous use, "TYPE B" or "TYPE D" OIL, sold only by Singer Sewing Machine Company, should be applied at least twice each day to all oil holes marked "OIL".

Copyright, U. S. A., 1917, 1921, 1922, 1930 and 1948  
by The Singer Manufacturing Co.  
All Rights Reserved for all Countries

## INDEX

---

Accessories.....	34
Edge Folders.....	34
Finger Guards.....	34
Foot Lifter.....	35
Guide (Adjustable, Hinged).....	36
Knee Lifter.....	36
Lap Seam Guide on Shank.....	37
Machine Base.....	37
Machine No. 55-3.....	7
Machine No. 55-4.....	14
Machine No. 55-5.....	21
Machine No. 55-6.....	27
Numerical List of Parts.....	43
Tape Holders.....	38
Thread Unwinders.....	39

From the library of: Diamond Needle Corp

## INSTRUCTIONS FOR ORDERING

In ordering from this list, use ONLY the part NUMBER in the FIRST column.

The number stamped on a Sewing Machine Part is in every case the number of the single part only.

Every combination of parts sent out as such has its specific number, which, although not stamped on the parts, must be used when ordering the combination.

Each number always indicates the SAME PART in whatever list it appears, or for whatever machine.

The letters after some of the numbers indicate the style of finish only, as follows:

- A-Hardened, Polished, Nickel Plated and Buffed
- A.A-Buffed and Chromium Plated
- A.B-Hardened, Polished, Buffed and Chromium Plated
- A.C-Brown Baking Enamel Finish
- A.D-Gray Baking Enamel Finish
- A.E-Hardened, Bright Rumbled and Nickel Plated
- A.F-Hardened, Bright Rumbled, Nickel Plated, Bright Rumbled and Chromium Plated
- A.G-Alumilite, Plain
- A.H-Alumilite, Dyed
- A.J-Polished, Nickel Plated and Chromium Plated
- A.K-Hardened, Polished, Nickel Plated and Chromium Plated
- A.L-Heat Treated for Toughness
  - B-Polished, Nickel Plated and Buffed
  - C-Hardened Only
- C.R-Hardened and Merlized
- D-Polished Only
- E-Soft, Not Polished
- F-Hardened and Polished
- F.J-Hardened, Polished and Nickel Plated
  - G-Bright Rumbled and Nickel Plated
- H-Blued
- J-Nickel Plated Only
- K-Hardened and Nickel Plated
- L-Brass Plated
- M-Oxidized
- N-Japanned, Dull
- P-Japanned, Bright
- P.P-Wrinkle Finish
- R-Merlized
- S-Cadmium Plated
- T-Copper Plated
- T.A-Hardened, Polished, Copper and Nickel Plated and Buffed
- T.B-Copper and Nickel Plated and Polished
- T.J-Copper and Nickel Plated Only
- T.K-Hardened, Copper and Nickel Plated
- T.L-Copper and Brass Plated
- T.M-Copper Plated and Oxidized

## INSTRUCTIONS FOR ORDERING - Continued

- U-Zinc Plated
- V-Silver Plated
- W-Polished and Nickel Plated
- X-Black Oxide, for Iron and Steel
- X.C-Hardened and Black Oxide, for Iron or Steel
- Y-Black Nickel Plated Only
- Z-Chromium Plated
- Z.A-Hardened, Polished, Nickel Plated, Buffed and Chromium Plated
- Z.B-Polished, Nickel Plated, Buffed and Chromium Plated
- Z.C-Hardened and Chromium Plated
- Z.D-Polished and Chromium Plated
- Z.G-Bright Rumbled, Nickel Plated, Bright Rumbled and Chromium Plated
- Z.J-Nickel and Chromium Plated
- Z.T-Copper and Chromium Plated

These letters MUST BE USED when they appear in the list; and AFTER the number as in the list.

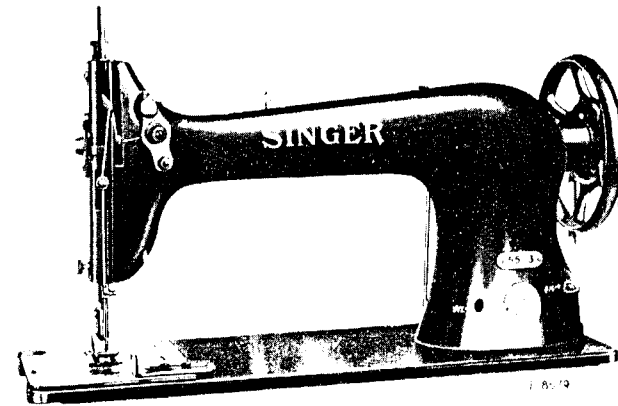
In this series:

- 1 to 1500, 50001 to 51500 and 140001 to 142000 are Screw Numbers
- 1501 to 1800 and 51501 to 51800 are Nut Numbers
- 1801 to 2000 and 51801 to 52000 are Roller Numbers
- 2001 to 50000 and 52001 to 140000 and 142001 to 190000 are Sewing Machine Parts, 190001 and upward are numbers of Electrical Parts.

The figures in the second column refer only to the plates, illustrating the parts, and are NOT TO BE USED in ordering.

Parts marked with an asterisk (\*) are furnished only when repairs are made at factory.

LIST OF PARTS COMPLETE  
FOR



MACHINE No. 55-3

For Stitching Bags with Twine or very Coarse Thread. Length of stitch 2 2/3 to 6 1/3 to the inch. One needle, One looper. Single and two-thread chain stitch. Speed 2500.

SINGER Needles should be used in SINGER Machines. These Needles and their Containers are marked with the Company's Trade-Mark "SIMANCO.\*\*\*" 1

Needles in Containers marked "FOR SINGER MACHINES" are NOT **SINGER** made needles. . 2

No.	Plate	Name
*18129	----	Arm with 15404 and two 15405
8582	22162	Arm Dowel Pin.....
12453	22162	Arm Oil Tube for intermediate bearing.....
12454	22162	Arm Oil Tube with 132590 for oiling 18189.....
11119	5170	Arm Oil Tube with 52045 for oiling 18190 and 18231.....
52045	22162	Arm Oil Tube Packing (cotton) for 11119.....
132590	22162	Arm Oil Tube (wick) for 12454.....
748E	5163	Arm Screw (back) (2).....
854E	5163	Arm Screw (front) (2).....
18131	22163	Arm Shaft.....
20905	----	Arm Shaft 18131 with 5570 and 20911.

From the library of: Diamond Needle Corp

No.	Plate	Name
12357	22162	Arm Shaft Flanged Bushing (back)....
448AL	5163	Arm Shaft Flanged Bushing Set Screw (2).....
144D	5163	Arm Shaft Screw.....
12480	22162	Arm Side Cap.....
219J	5163	Arm Side Cap Screw.....
12193	22164	Arm Side Cover.....
51224W	22162	Arm Side Cover Thumb Screw.....
4388	5150	Balance Wheel (power) light rim, 2 3/4 in. pulley with two 448AL.....
4370	5150	Balance Wheel (stand) heavy rim, 2 3/4 in. pulley with two 448AL.....
56899	-----	Balance Wheel (light rim) "V" belt groove (outside diam of belt groove 2.9 in.) with two 435AL....
24297	22164	Balance Wheel Oil Cover for use with 2135 and 2362.....
210J	22162	Balance Wheel Oil Cover Screw.....
448AL	5163	Balance Wheel Set Screw (2).....
435AL	22162	Balance Wheel Set Screw for 56899 (2).....
*20912	-----	Bed.....
18133	5172	Bed Oil Hole Cover.....
1044E	5172	Bed Oil Hole Cover Hinge Screw.....
18134	5168	Cloth Plate.....
18317	-----	Cloth Plate 18134 with 1044E and 18133.....
691F	5163	Cloth Plate Screw (3).....
20197	22164	Crank Connecting Rod with two 896AL.
896AL	5163	Crank Connecting Rod Cap Screw (2)..
908C	5163	Crank Connecting Rod Hinge Screw....
1619E	5164	Crank Connecting Rod Hinge Screw Nut
18135	-----	Face Plate.....
18136	5167	Face Plate complete, Nos. 66F, 1521E 18135, 18169, 18170 and two 219F..
190J	5171	Face Plate Screw.....
51224W	22162	Face Plate Thumb Screw.....
20913	5240	Feed Bar with 176J.....
176J	22165	Feed Bar Adjusting Screw.....
1045C	5169	Feed Bar Hinge Screw.....
1518J	5169	Feed Bar Hinge Screw Nut.....
313C	5163	Feed Bar Screw Center (2).....
56813	-----	Feed Bar Screw Center 313C with 1519J (2).....
1519J	5164	Feed Bar Screw Center Nut (2).....
18140	5175	Feed Dog, 17 teeth (12 teeth to the inch) for 18193 and 18194.....
18326	5175	Feed Dog, 23 teeth (16 teeth to the inch) for 18193 and 18194.....
18208	5175	Feed Dog, 12 teeth ( 8 teeth to the inch) for 18193 and 18194.....
18211	5176	Feed Dog, 17 teeth (12 teeth to the inch) for 18214 and 18298.....
18216	5176	Feed Dog, 15 teeth (10 teeth to the inch) for 18217.....

No.	Plate	Name
18218	5177	Feed Dog, 14 teeth (10 teeth to the inch) for 18219.....
898J	22165	Feed Dog Screw.....
5570	22165	Feed Eccentric with 448AL.....
18141	5167	Feed Eccentric Connecting Rod with 896AL and two 145E.....
20901	-----	Feed Eccentric Connecting Rod 18141 with 389F, 697C and 11137.....
896AL	5163	Feed Eccentric Connecting Rod Adjust- ing Screw.....
145E	5169	Feed Eccentric Connecting Rod Cap Screw (2).....
697C	5169	Feed Eccentric Connecting Rod Stud..
389F	5169	Feed Eccentric Connecting Rod Stud Cap Screw.....
11137	5169	Feed Eccentric Connecting Rod Stud Cap Screw Washer.....
1518J	5169	Feed Eccentric Connecting Rod Stud Nut.....
2018	5169	Feed Eccentric Connecting Rod Stud Nut Washer.....
446AL	5163	Feed Eccentric Set Screw.....
18142	5169	Feed Lifting Eccentric with 446AL...
18143	5169	Feed Lifting Eccentric Connection...
18144	5169	Feed Lifting Eccentric Oil Pad.....
446AL	5163	Feed Lifting Eccentric Set Screw....
18145	22163	Feed Rock Shaft.....
20904	-----	Feed Rock Shaft 18145 with 18146 to 18148.....
18146	5169	Feed Rock Shaft Regulator Crank with 790C and two 1147AL.....
790C	5169	Feed Rock Shaft Regulator Crank Position Screw.....
1147AL	5169	Feed Rock Shaft Regulator Crank Set Screw (2).....
307C	5163	Feed Rock Shaft Screw Center (2)....
56814	-----	Feed Rock Shaft Screw Center 307C with 1513J (2).....
1513J	5164	Feed Rock Shaft Screw Center Nut (2)
18147	5169	Feed Rock Shaft Screw Center Oil Tube (crank end).....
18148	5169	Feed Rock Shaft Screw Center Oil Tube (feed bar end).....
26463	956	Guide (1 1/2 in. face).....
26693	956	Guide (4 in. face).....
190J	5171	Guide Screw.....
7071	22165	Guide Screw Washer.....
18149	5176	Loop Retainer, for single thread....
335D	5176	Loop Retainer Screw.....
18299	22166	Looper with 1120AL and 1389F, for double thread.....
18300	22166	Looper with 1120AL and 1389F, for single thread.....
1389F	22165	Looper Position Screw.....

No.	Plate	Name
1120AL	22165	Looper Set Screw.....
18152	22163	Looper Shaft.....
18319	-----	Looper Shaft 18152 with 18142, 18143, 18183 and 19447.....
19496	-----	Looper Shaft Crank.....
19447	22165	Looper Shaft Crank complete, Nos. 457AL, 1518J, 19449 and 19496.....
2049	22165	Looper Shaft Crank Pin.....
457AL	5164	Looper Shaft Crank Set Screw.....
19448	22165	Looper Shaft Crank Slide Block.....
226J	22165	Looper Shaft Crank Slide Block Cap Screw.....
12424	22165	Looper Shaft Crank Slide Block Cap Screw Washer.....
988C	22165	Looper Shaft Crank Slide Block Screw Stud.....
1518J	5169	Looper Shaft Crank Slide Block Screw Stud Nut.....
19449	-----	Looper Shaft Crank Slide Block com- plete, Nos. 226J, 988C, 12424 and 19448.....
18153	5169	Looper Shaft Oil Cup.....
18154	5169	Looper Shaft Oil Cup Packing.....
18098	22164	Needle Bar (hollow).....
18308	-----	Needle Bar 18098 with 2273 and 18161
18301	22165	Needle Bar Connecting Link with 794E and 12384.....
794E	5170	Needle Bar Connecting Link Adjusting Screw.....
12384	22165	Needle Bar Connecting Stud with 453AL and 1904.....
1904	22165	Needle Bar Connecting Stud Roller (roller only).....
453AL	5164	Needle Bar Connecting Stud Set Screw
18231	5167	Needle Bar Crank and Thread Nipper Eccentric with 448AL and 1065AL...
20911	-----	Needle Bar Crank and Thread Nipper Eccentric 18231 with 18173.....
1065AL	5163	Needle Bar Crank and Thread Nipper Eccentric Position Screw.....
448AL	5163	Needle Bar Crank and Thread Nipper Eccentric Set Screw.....
936D	5163	Needle Bar Screw Bushing (2).....
18157	5170	Needle Bar Thread Retainer Bracket..
18343	-----	Needle Bar Thread Retainer Bracket complete, Nos. 453AL, 462AL, 12400, 18157, 18159, 18344 and 20910.....
453AL	5164	Needle Bar Thread Retainer Bracket Set Screw.....
12400	5170	Needle Bar Thread Retainer Sleeve...
18159	5170	Needle Bar Thread Retainer Spring...
20910	22165	Needle Bar Thread Retaining Collar..
18344	22165	Needle Bar Thread Retaining Stud....
462AL	5170	Needle Bar Thread Retaining Stud Set Screw.....

No.	Plate	Name
18161	5170	Needle Clamp with 209AL.....
2273	22165	Needle Clamp Pin.....
209AL	22165	Needle Set Screw.....
*18162	-----	Oscillating Rock Shaft.....
18163	-----	Oscillating Rock Shaft complete, Nos. 4784, 12388 and 18162.....
12388	22164	Oscillating Rock Shaft Hinge Pin....
878J	5163	Oscillating Rock Shaft Hinge Pin Oil Hole Stop Screw.....
12459	22170	Oscillating Rock Shaft Hinge Pin Oil Hole Stop Screw Washer (leather)..
448AL	5163	Oscillating Rock Shaft Hinge Pin Set Screw.....
4784	22170	Oscillating Rock Shaft Oil Pad.....
18164	5167	Presser Bar.....
52016	22170	Presser Bar Lifter.....
689C	22175	Presser Bar Lifter Screw.....
1520J	5164	Presser Bar Lifter Screw Nut.....
11167	22164	Presser Bar Spring (light).....
12139	22164	Presser Bar Spring (medium).....
20023	22164	Presser Bar Spring (heavy).....
		Note: No. 11167 is sent with the Machine unless another Spring is specified on order.
20926	22169	Presser Bar Spring Bracket with 453AL.....
453AL	5164	Presser Bar Spring Bracket Set Screw
11170	22170	Presser Bar Spring Washer.....
18165	-----	Presser Foot Body.....
18325	22170	Presser Foot Hinge Pin.....
18166	-----	Presser Foot Plate.....
18200	5180	Presser Foot Spring for heavy work..
18201	5180	Presser Foot Spring for light work..
889AL	5180	Presser Foot Spring Adjusting Screw.
18167	5180	Presser Foot Spring Stud.....
18168	5180	Presser Foot (spring hinged) com- plete, Nos. 889AL, 18165 to 18167, 18200, 18201 and 18325.....
18215	-----	Presser Foot Body.....
18325	22170	Presser Foot Hinge Pin.....
18212	-----	Presser Foot Plate.....
18200	5180	Presser Foot Spring, for heavy work.
18201	5180	Presser Foot Spring, for light work.
889AL	5180	Presser Foot Spring Adjusting Screw.
18167	5180	Presser Foot Spring Stud.....
18213	5180	Presser Foot (spring hinged) com- plete for 18211, Nos. 889AL, 18167, 18200, 18201, 18212, 18215 and 18325.....
190J	5171	Presser Foot Screw.....
688W	5163	Pressure Regulating Thumb Screw....
18169	5172	Slack Thread Regulator.....
18170	5172	Slack Thread Regulator Adjusting Bracket.....
219F	5163	Slack Thread Regulator Adjusting Bracket Screw (2).....

No.	Plate	Name
66F	5172	Slack Thread Regulator Hinge Screw..
1521E	5171	Slack Thread Regulator Hinge Screw Nut.....
18111	5172	Slack Thread Regulator Link with 1919.....
766D	5172	Slack Thread Regulator Link Hinge Screw.....
1919	5172	Slack Thread Regulator Link Roller and Stud.....
2102	22170	Tension (under thread) Disc (2).....
1560C	22170	Tension (under thread) Regulating Thumb Nut.....
686E	5171	Tension (under thread) Screw Stud....
58590	-----	Tension (under thread) Screw Stud 686E with 1560C.....
10148	5171	Tension (under thread) Spring.....
2921	5171	Tension (upper thread) Disc (2).....
13589	5171	Tension (upper thread) Disc Steady Pin.....
1560C	22170	Tension (upper thread) Regulating Thumb Nut.....
1046C	5171	Tension (upper thread) Screw Stud....
20914	-----	Tension (upper thread) Screw Stud 1046C with 1560C.....
8238	22170	Tension (upper thread) Spring.....
18172	5171	Thread Eyelet (top of arm).....
18171	5171	Thread (under) Eyelet.....
191C	5171	Thread (under) Eyelet Screw.....
9525	5171	Thread (under) Eyelet Screw Washer..
18184	5171	Thread (under) Take-up Arm.....
18185	5171	Thread (under) Take-up Arm Body with 453AL.....
453AL	5164	Thread (under) Take-up Body Set Screw.....
18183	-----	Thread (under) Take-up complete, Nos. 18184 and 18185.....
18186	5171	Thread (under) Take-up Eyelet.....
190J	5171	Thread (under) Take-up Eyelet Screw..
145E	5169	Thread (upper) Nipper Connection Cap Screw (2).....
18175	-----	Thread (upper) Nipper Connection Rod
2532	5171	Thread (upper) Nipper Connection Rod Dowel Pin.....
18173	5171	Thread (upper) Nipper Connection complete, Nos. 2532, 18175 and two 145E.....
18177	5171	Thread (upper) Nipper Connection Sleeve.....
18180	5171	Thread (upper) Nipper Plate with 13589.....
18181	5171	Thread (upper) Nipper Plate Stud and Thread Eyelet.....
175F	5171	Thread (upper) Nipper Plate Stud and Thread Eyelet Set Screw.....
18182	5171	Thread (upper) Nipper Plate Washer..

No.	Plate	Name
1521J	5171	Thread (upper) Nipper Regulating Nut
1521J	5171	Thread (upper) Nipper Regulating Lock Nut.....
18187	5170	Thread (upper) Take-up Crank.....
3094	5170	Thread (upper) Take-up Crank Wedge..
*5750	-----	Thread (upper) Take-up Crank Wedge 3094 with 690E.....
690E	5170	Thread (upper) Take-up Crank Wedge Screw.....
18188	5170	Thread (upper) Take-up Lever.....
18189	5170	Thread (upper) Take-up Lever Arm....
11204	5170	Thread (upper) Take-up Lever Hinge Pin.....
430C	5170	Thread (upper) Take-up Lever Hinge Pin Set Screw.....
18190	5170	Thread (upper) Take-up Lever Link...
775E	5170	Thread (upper) Take-up Lever Link Cap Screw.....
20995	22170	Thread (upper) Take-up Lever Rivet (2).....
18192	-----	Thread (upper) Take-up Lever com- plete, Nos. 18188, 18189 and two 20995.....
18323	-----	Thread (upper) Take-up Lever, 18192 with 775E, 11204, 18187 and 18190.
18298	22167	Throat Plate, for double thread, for 18211.....
18193	5175	Throat Plate, for double thread, for 18140, 18208 and 18326.....
18194	5175	Throat Plate with 335D and 18149 for single thread, for 18140, 18208 and 18326.....
18214	5176	Throat Plate with 335D and 18149, for single thread, for 18211.....
18217	5176	Throat Plate with 335D and 18149, for single thread, for 18216.....
18219	5177	Throat Plate with 335D and 18149, for single thread, for 18218.....
742F	5171	Throat Plate Screw (2).....
139637	22176	Drip Pan with four 1 in. wire nails.
*15404	-----	Trade Mark.....
15405	-----	Trade Mark Rivet (2).....

## LIST OF PARTS COMPLETE

FOR

## MACHINE No. 55-4

For Stitching Bags with Twine or very Coarse Thread. Length of stitch  $2\frac{2}{3}$  to  $6\frac{1}{3}$  to the inch. Two needles, Two loopers. Single and two-thread chain stitch. Gauges from  $\frac{7}{16}$ " to  $1\frac{1}{4}$ ", in steps of  $\frac{1}{16}$ ". Speed 2500.

No.	Plate	Name
*18272	-----	Arm with 15404 and two 15405.....
8582	22162	Arm Dowel Pin.....
12453	22162	Arm Oil Tube, for intermediate bearing.....
12454	22162	Arm Oil Tube with 132590 for oiling 18189.....
11119	5170	Arm Oil Tube with 52045 for oiling 18190 and 18231.....
52045	22162	Arm Oil Tube Packing (cotton) for 11119.....
132590	22162	Arm Oil Tube Packing (wick) for 12454.....
748E	5163	Arm Screw (back) (2).....
854E	5163	Arm Screw (front) (2).....
18131	22163	Arm Shaft.....
20905	-----	Arm Shaft 18131 with 5570 and 20911.....
12357	22162	Arm Shaft Flanged Bushing (back)....
448AL	5163	Arm Shaft Flanged Bushing Set Screw (2).....
144D	5163	Arm Shaft Screw.....
12480	22162	Arm Side Cap.....
219J	5163	Arm Side Cap Screw.....
12193	22164	Arm Side Cover.....
51224W	22162	Arm Side Cover Thumb Screw.....
4388	5150	Balance Wheel (power) light rim, 2 $\frac{3}{4}$ in. pulley, with two 448AL....
4370	5150	Balance Wheel (stand) heavy rim, 2 $\frac{3}{4}$ in. pulley, with two 448AL....
2135	5150	Balance Wheel (stand) heavy rim, 2 $\frac{1}{2}$ in. pulley, for 3022.....
2862	5150	Balance Wheel (stand) heavy rim, 3 in. pulley, for 3022.....
56899	-----	Balance Wheel (light rim) "V" belt groove (outside diam. of belt groove 2.9 in.) with two 435AL....
24297	22164	Balance Wheel Oil Cover for use with 2135 and 2862.....
210J	22162	Balance Wheel Oil Cover Screw.....
448AL	5163	Balance Wheel Set Screw (2).....
435AL	22162	Balance Wheel Set Screw for 56899 (2).....

No.	Plate	Name
*20912	-----	Bed.....
18133	5172	Bed Oil Hole Cover.....
1044E	5172	Bed Oil Hole Cover Hinge Screw.....
256J	22162	Clamp Stop Motion Clamp Screw.....
248A	5163	Clamp Stop Motion Clamp Stop Screw..
2020	22162	Clamp Stop Motion Clamp Washer.....
*3023	-----	Clamp Stop Motion Flanged Bushing...
4933	-----	Clamp Stop Motion Flanged Bushing 3023 with two 462AL.....
*56827	-----	Clamp Stop Motion Flanged Bushing 3023 with 256J.....
2022	-----	Clamp Stop Motion Flanged Bushing Fin.....
462AL	5170	Clamp Stop Motion Flanged Bushing Set Screw (2).....
3022	-----	Clamp Stop Motion complete, Nos. 248A, 256J, 2020 and 4933.....
18134	5168	Cloth Plate.....
18317	-----	Cloth Plate 18134 with 1044E and 18133.....
18294	5237	Cloth Plate for 18289 and 18290.....
18295	5237	Cloth Plate for 18292 and 18293.....
691F	5163	Cloth Plate Screw (3).....
20197	22164	Crank Connecting Rod with two 896AL
896AL	5163	Crank Connecting Rod Cap Screw (2)
908C	5163	Crank Connecting Rod Hinge Screw...
1619E	5164	Crank Connecting Rod Hinge Screw Nu
18273	-----	Face Plate.....
18274	5236	Face Plate complete, Nos. 66F, 152E, 18169, 18170, 18273 and two 219F.....
190J	5171	Face Plate Screw.....
51224W	22162	Face Plate Thumb Screw.....
20913	5240	Feed Bar with 176J.....
176J	22165	Feed Bar Adjusting Screw.....
1045C	5169	Feed Bar Hinge Screw.....
1518J	5169	Feed Bar Hinge Screw Nut.....
313C	5163	Feed Bar Screw Center (2).....
56813	-----	Feed Bar Screw Center 313C with 1519J (2).....
1519J	5164	Feed Bar Screw Center Nut (2).....
18275	5203	Feed Dog, for $\frac{7}{16}$ in. to $\frac{5}{8}$ in. gauges, for 18286 and 18287.....
18288	5204	Feed Dog, for $\frac{11}{16}$ in. to $1\frac{1}{8}$ in. gauges for 18289 and 18290.....
18291	5206	Feed Dog, for $1\frac{3}{16}$ in. to $1\frac{1}{4}$ in. gauges for 18292 and 18293.....
898J	22165	Feed Dog Screw.....
5570	22165	Feed Eccentric with 446AL.....
18141	5167	Feed Eccentric Connecting Rod with 896AL and two 145E.....
20901	-----	Feed Eccentric Connecting Rod 18141 with 389F, 697C and 11137.....
896AL	5163	Feed Eccentric Connecting Rod Adjusting Screw.....
145E	5169	Feed Eccentric Connecting Rod Cap Screw (2).....

From the library of International Needle Corp.



No.	Plate	Name
697C	5169	Feed Eccentric Connecting Rod Stud..
389F	5169	Feed Eccentric Connecting Rod Stud Cap Screw.....
11137	5169	Feed Eccentric Connecting Rod Stud Cap Screw Washer.....
1518J	5169	Feed Eccentric Connecting Rod Stud Nut.....
2018	5169	Feed Eccentric Connecting Rod Stud Nut Washer.....
446AL	5163	Feed Eccentric Set Screw.....
18142	5169	Feed Lifting Eccentric with 446AL...
18143	5169	Feed Lifting Eccentric Connection...
18144	5169	Feed Lifting Eccentric Oil Pad.....
446AL	5163	Feed Lifting Eccentric Set Screw....
18145	22163	Feed Rock Shaft.....
20904	-----	Feed Rock Shaft 18145 with 18146 to 18148.....
18146	5169	Feed Rock Shaft Regulator Crank with 790C and two 1147AL.....
790C	5169	Feed Rock Shaft Regulator Crank Position Screw.....
1147AL	5169	Feed Rock Shaft Regulator Crank Set Screw (2).....
307C	5163	Feed Rock Shaft Screw Center (2)....
56814	-----	Feed Rock Shaft Screw Center 307C with 1513J (2).....
1513J	5164	Feed Rock Shaft Screw Center Nut (2)
18147	5169	Feed Rock Shaft Screw Center Oil Tube (crank end).....
18148	5169	Feed Rock Shaft Screw Center Oil Tube (feed bar end).....
26463	956	Guide (1 1/2 in. face).....
26693	956	Guide (4 in. face).....
190J	5171	Guide Screw.....
7071	22165	Guide Screw Washer.....
18149	5176	Loop Retainer, for single thread....
335D	5176	Loop Retainer Screw.....
18300	22166	Looper (inside) with 1120AL and 1389F, for single thread.....
18300	22166	Looper (outside) with 1120AL and 1389F, for single thread.....
18119	22166	Looper (inside) with 1076C, for No. 23 needle, for 13/64 in. gauge and above.....
18120	22166	Looper (outside) with 1076C, for No. 23 needle, for 13/64 in. gauge and above.....
18299	22166	Looper (inside) with 1120AL and 1389F for double thread.....
18299	22166	Looper (outside) with 1120AL and 1389F, for double thread.....
1389F	22165	Looper Position Screw.....
1120AL	22165	Looper Set Screw.....
1076C	22170	Looper Set Screw.....
18276	22163	Looper Shaft.....

Note: When ordering No. 18276, state gauge  
required.

No.	Plate	Name
18320	-----	Looper Shaft 18276 with 18142, 18143, 18185 and 19447.....
19496	-----	Looper Shaft Crank.....
19447	22165	Looper Shaft Crank complete, Nos. 457AL, 1518J, 19449 and 19496.....
2049	22165	Looper Shaft Crank Pin.....
457AL	5164	Looper Shaft Crank Set Screw.....
19448	22165	Looper Shaft Crank Slide Block.....
226J	22165	Looper Shaft Crank Slide Block Cap Screw.....
12424	22165	Looper Shaft Crank Slide Block Cap Screw Washer.....
988C	22165	Looper Shaft Crank Slide Block Screw Stud.....
1518J	5169	Looper Shaft Crank Slide Block Screw Stud Nut.....
19449	-----	Looper Shaft Crank Slide Block com- plete, Nos. 226J, 988C, 12424 and 19448.....
18153	5169	Looper Shaft Oil Cup.....
18154	5169	Looper Shaft Oil Cup Packing.....
18098	22164	Needle Bar (hollow).....
18144	-----	Needle Bar 18098 with 2273 and 18099
18301	22165	Needle Bar Connecting Link with 794E and 12384.....
794E	5170	Needle Bar Connecting Link Adjusting Screw.....
18384	22165	Needle Bar Connecting Stud with 453AL and 1904.....
1904	22165	Needle Bar Connecting Stud Roller (roller only).....
453AL	5164	Needle Bar Connecting Stud Set Screw
18231	5167	Needle Bar Crank and Thread Nipper Eccentric with 448AL and 1065AL..
20911	-----	Needle Bar Crank and Thread Nipper Eccentric 18231 with 18173.....
1065AL	5163	Needle Bar Crank and Thread Nipper Eccentric Position Screw.....
448AL	5163	Needle Bar Crank and Thread Nipper Eccentric Set Screw.....
936D	5163	Needle Bar Screw Bushing (2).....
18157	5170	Needle Bar Thread Retainer Bracket..
18345	-----	Needle Bar Thread Retainer Bracket complete, Nos. 453AL, 462AL, 12400 18157, 18159, 18346, 20910 and 21020.....
453AL	5164	Needle Bar Thread Retainer Bracket Set Screw.....
12400	5170	Needle Bar Thread Retainer Sleeve...
18159	5170	Needle Bar Thread Retainer Spring...
20910	22165	Needle Bar Thread Retaining Collar..
18346	22170	Needle Bar Thread Retaining Stud....
462AL	5170	Needle Bar Thread Retaining Stud Set Screw.....
21020	5172	Needle Bar Thread Retaining Thread Separator.....

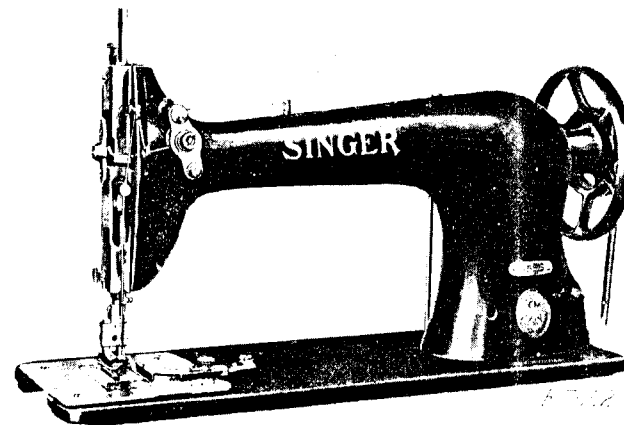
No.	Plate	Name
18052	5172	Needle Clamp with two 209AL.....
Note: When ordering No. 18052, state gauge required.		
2273	22165	Needle Clamp Pin.....
209AL	22165	Needle Set Screw (2).....
*18162	-----	Oscillating Rock Shaft.....
18163	-----	Oscillating Rock Shaft complete, Nos. 4784, 12388 and 18162.....
12388	22164	Oscillating Rock Shaft Hinge Pin.....
878J	5163	Oscillating Rock Shaft Hinge Pin Oil Hole Stop Screw.....
12459	22170	Oscillating Rock Shaft Hinge Pin Oil Hole Stop Screw Washer (leather)...
448AL	5163	Oscillating Rock Shaft Hinge Pin Set Screw.....
4784	22170	Oscillating Rock Shaft Oil Pad.....
18164	5167	Presser Bar.....
52016	22170	Presser Bar Lifter.....
689C	22175	Presser Bar Lifter Screw.....
1520J	5164	Presser Bar Lifter Screw Nut.....
20023	22164	Presser Bar Spring (heavy).....
11167	22164	Presser Bar Spring (light).....
Note: No. 11167 is sent with this Machine unless another spring is specified on order.		
12139	22164	Presser Bar Spring (medium).....
11168	22169	Presser Bar Spring Bracket with 453AL
453AL	5164	Presser Bar Spring Bracket Set Screw.
11170	22170	Presser Bar Spring Washer.....
18279	-----	Presser Foot Body.....
18280	22170	Presser Foot Hinge Pin.....
18281	-----	Presser Foot Plate.....
18200	5180	Presser Foot Spring, for heavy work..
18201	5180	Presser Foot Spring, for light work..
889AL	5190	Presser Foot Spring Adjusting Screw..
18167	5180	Presser Foot Spring Stud.....
18282	5203	Presser Foot (spring hinged) complete for 18275, Nos. 889AL, 18167, 18200, 18201 and 18279 to 18281....
18055	22170	Presser Foot Hinge Pin.....
18195	-----	Presser Foot Plate.....
18196	-----	Presser Foot Shank.....
18197	22167	Presser Foot (tube) Hinged complete, Nos. 18055, 18195 and 18196.....
190J	5171	Presser Foot Screw.....
688W	5163	Pressure Regulating Thumb Screw.....
18169	5172	Slack Thread Regulator.....
18170	5172	Slack Thread Regulator Adjusting Bracket.....
219F	5163	Slack Thread Regulator Adjusting Bracket Screw (2).....
66F	5172	Slack Thread Regulator Hinge Screw...
1521E	5171	Slack Thread Regulator Hinge Screw Nut.....

No.	Plate	Name
18111	5172	Slack Thread Regulator Link with 1919
766D	5172	Slack Thread Regulator Link Hinge Screw.....
1919	5172	Slack Thread Regulator Link Roller and Stud.....
2102	22170	Tension (under thread) Disc (2).....
18283	22169	Tension (under thread) Eyelet (double)
1560C	22170	Tension (under thread) Regulating Thumb Nut.....
686E	5171	Tension (under thread) Screw Stud....
58590	-----	Tension (under thread) Screw Stud 686E with 1560C.....
13550	22169	Tension (under thread) Separating Disc.....
10148	5171	Tension (under thread) Spring.....
2921	5171	Tension (upper thread) Disc (2).....
13589	5171	Tension (upper thread) Disc Steady Pin.....
1560C	22170	Tension (upper thread) Regulating Thumb Nut.....
1046C	5171	Tension (upper thread) Screw Stud....
20914	-----	Tension (upper thread) Screw Stud 1046C and 1560C.....
8238	22170	Tension (upper thread) Spring.....
23868	22169	Thread Eyelet (top of arm).....
18171	5171	Thread (under) Eyelet.....
191C	5171	Thread (under) Eyelet Screw.....
9525	5171	Thread (under) Eyelet Screw Washer...
18184	5171	Thread (under) Take-up Arm.....
18185	5171	Thread (under) Take-up Arm Body with 453AL.....
453AL	5164	Thread (under) Take-up Body Set Screw
18183	-----	Thread (under) Take-up complete, Nos. 18184 and 18185.....
18186	5171	Thread (under) Take-up Eyelet.....
190J	5171	Thread (under) Take-up Eyelet Screw..
145E	5169	Thread (upper) Nipper Connection Cap Screw (2).....
18175	-----	Thread (upper) Nipper Connection Rod.
2532	5171	Thread (upper) Nipper Connection Rod Dowel Pin.....
18173	5171	Thread (upper) Nipper Connection complete, Nos. 2532, 18175 and two 145E.....
18177	5171	Thread (upper) Nipper Connection Sleeve.....
18180	5171	Thread (upper) Nipper Plate with 13589.....
18312	22169	Thread (upper) Nipper Plate Stud and Thread Eyelet.....
175F	5171	Thread (upper) Nipper Plate Stud and Thread Eyelet Set Screw.....
18182	5171	Thread (upper) Nipper Plate Washer...
1521J	5171	Thread (upper) Nipper Regulating Nut.

No.	Plate	Name
1521J	5171	Thread (upper) Nipper Regulating Nut Lock Nut.....
13550	22169	Thread (upper) Nipper Separating Disc.....
18187	5170	Thread (upper) Take-up Crank.....
3094	5170	Thread (upper) Take-up Crank Wedge..
*5750	-----	Thread (upper) Take-up Crank Wedge 3094 with 690E.....
690E	5170	Thread (upper) Take-up Crank Wedge Screw.....
18284	5172	Thread (upper) Take-up Lever.....
18189	5170	Thread (upper) Take-up Lever Arm....
11204	5170	Thread (upper) Take-up Lever Hinge Pin.....
4300	5170	Thread (upper) Take-up Lever Hinge Pin Set Screw.....
18190	5170	Thread (upper) Take-up Lever Link...
775E	5170	Thread (upper) Take-up Lever Link Cap Screw.....
20995	22170	Thread (upper) Take-up Lever Rivet (2).....
18285	-----	Thread (upper) Take-up Lever com- plete, Nos. 18189, 18284 and two 20995.....
18324	-----	Thread (upper) Take-up Lever 18285 with 775E, 11204, 18187 and 18190.
18286	5203	Throat Plate, for double thread, for 18275.....
18287	5203	Throat Plate with two each 335D and 18149, for single thread, for 18275.....
18289	5204	Throat Plate, for double thread, for 18288.....
18290	5205	Throat Plate with two each 335D and 18149, for single thread, for 18288.....
18292	5206	Throat Plate for double thread, for 18291.....
18293	5207	Throat Plate with two each 335D and 18149, for single thread, for 18291.....
742F	5171	Throat Plate Screw (2).....
139637	22176	Drip Pan with four 1 in. wire nails.
*15404	-----	Trade Mark.....
15405	-----	Trade Mark Rivet (2).....

## LIST OF PARTS COMPLETE

FOR



## MACHINE No. 55-5

For Basting. Length of stitch 2 to 4 to the  
inch. One needle, One looper. Single thread  
chain stitch. Speed 2500.

No.	Plate	Name
*18129	-----	Arm with 15404 and two 15405.....
8582	22162	Arm Dowel Pin.....
12453	22162	Arm Oil Tube, for intermediate bearing.....
12454	22162	Arm Oil Tube with 132590 for oiling 18189.....
11119	5170	Arm Oil Tube with 52045 for oiling 18190 and 18231.....
52045	22162	Arm Oil Tube Packing (cotton) for 11119.....
132590	22162	Arm Oil Tube Packing (wisk) for 12454.....
748E	5163	Arm Screw (back) (2).....
854E	5163	Arm Screw (front) (2).....
18131	22163	Arm Shaft.....

No.	Plate	Name
20907	-----	Arm Shaft 18131 with 18309 and 20911
12357	22162	Arm Shaft Flanged Bushing (back)....
448AL	5163	Arm Shaft Flanged Bushing Set Screw (2).....
144D	5163	Arm Shaft Screw.....
12480	22162	Arm Side Cap.....
219J	5163	Arm Side Cap Screw.....
12193	22164	Arm Side Cover.....
51224W	22162	Arm Side Cover Thumb Screw.....
4388	5150	Balance Wheel (power) light rim, 2 3/4 in. pulley with two 448AL.....
56899	-----	Balance Wheel (light rim) "V" belt groove (outside diam of belt groove 2.9 in.) with two 435AL....
448AL	5163	Balance Wheel Set Screw (2).....
435AL	22162	Balance Wheel Set Screw for 56899 (2).....
*20912	-----	Bed.....
18133	5172	Bed Oil Hole Cover.....
1044E	5172	Bed Oil Hole Cover Hinge Screw.....
18134	5168	Cloth Plate.....
18317	-----	Cloth Plate 18134 with 1044E and 18133.....
691F	5163	Cloth Plate Screw (3).....
20197	22164	Crank Connecting Rod with two 896AL.
896AL	5163	Crank Connecting Rod Cap Screw (2)..
908C	5163	Crank Connecting Rod Hinge Screw....
1619E	5164	Crank Connecting Rod Hinge Screw Nut
18135	-----	Face Plate.....
18136	5167	Face Plate complete, Nos. 66F, 1521E, 18135, 18169, 18170 and two 219F..
190J	5171	Face Plate Screw.....
51224W	22162	Face Plate Thumb Screw.....
20913	5240	Feed Bar with 176J.....
176J	22165	Feed Bar Adjusting Screw.....
1045C	5169	Feed Bar Hinge Screw.....
1518J	5169	Feed Bar Hinge Screw Nut.....
313C	5163	Feed Bar Screw Center (2).....
56813	-----	Feed Bar Screw Center 313C with 1519J (2).....
1519J	5164	Feed Bar Screw Center Nut (2).....
120371	22167	Feed Dog, for basting for 120376....
20916	22167	Feed Dog for 20917.....
898J	22165	Feed Dog Screw.....
18309	5240	Feed Eccentric with two 448AL.....
20927	22163	Feed Eccentric Connecting Rod with 896AL and two 145E.....
20928	-----	Feed Eccentric Connecting Rod 20927 with 389F, 697C and 11137.....
896AL	5163	Feed Eccentric Connecting Rod Adjust- ing Screw.....
145E	5169	Feed Eccentric Connecting Rod Cap Screw (2).....
697C	5169	Feed Eccentric Connecting Rod Stud..
389F	5169	Feed Eccentric Connecting Rod Stud Cap Screw.....

No.	Plate	Name
11137	5169	Feed Eccentric Connecting Rod Stud Cap Screw Washer.....
1518J	5169	Feed Eccentric Connecting Rod Stud Nut.....
2018	5169	Feed Eccentric Connecting Rod Stud Nut Washer.....
448AL	5163	Feed Eccentric Set Screw (2).....
18142	5169	Feed Lifting Eccentric with 446AL...
18143	5169	Feed Lifting Eccentric Connection...
18144	5169	Feed Lifting Eccentric Oil Pad.....
446AL	5163	Feed Lifting Eccentric Set Screw....
18145	22163	Feed Rock Shaft.....
20904	-----	Feed Rock Shaft 18145 with 18146 to 18148.....
18146	5169	Feed Rock Shaft Regulator Crank with 790C and two 1147AL.....
790C	5169	Feed Rock Shaft Regulator Crank Position Screw.....
1147AL	5169	Feed Rock Shaft Regulator Crank Set Screw (2).....
307C	5163	Feed Rock Shaft Screw Center (2)....
56814	-----	Feed Rock Shaft Screw Center 307C with 1513J (2).....
1513J	5164	Feed Rock Shaft Screw Center Nut (2)
18147	5169	Feed Rock Shaft Screw Center Oil Tube (crank end).....
18148	5169	Feed Rock Shaft Screw Center Oil Tube (feed bar end).....
120372	22171	Guide for basting, for 120373.....
28971	22171	Guide for 120428.....
28972	22171	Guide Holder.....
35610	22171	Guide Holder Friction Washer.....
940W	22171	Guide Holder Hinge Screw.....
28973	22171	Guide Holder Shank for 120373.....
120427	22171	Guide Holder Shank for 120428.....
51224W	22162	Guide Thumb Screw.....
7071	22165	Guide Thumb Screw Washer.....
120428	22171	Guide (adjustable, hinged) complete, Nos. 940W, 7071, 28971, 28972, 35610, 51224W and 120427.....
120373	22171	Guide (adjustable, hinged) complete, for basting, Nos. 940W, 7071, 28972, 28973, 35610, 51224W and 120372...
190J	5171	Guide Adjusting Screw.....
7071	22165	Guide Adjusting Screw Washer.....
184E	22171	Guide Screw Stud.....
18149	5176	Loop Retainer, for single thread....
335D	5176	Loop Retainer Screw.....
18300	22166	Looper with 1120AL and 1389F, for single thread.....
1389F	22165	Looper Position Screw.....
1120AL	22165	Looper Set Screw.....
18152	22163	Looper Shaft.....
18319	-----	Looper Shaft 18152 with 18142, 18143 18183 and 19447.....

Join the library of Diamond Feed Corp

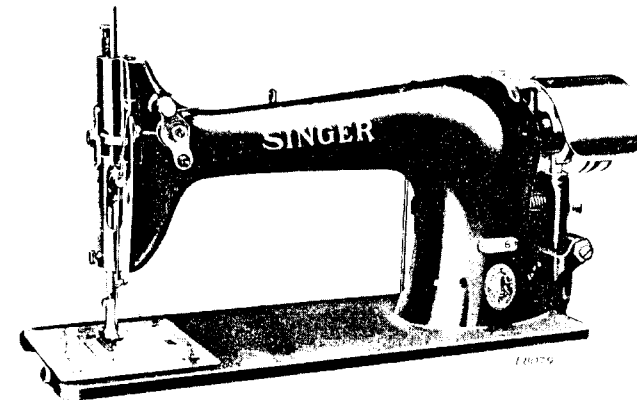
No.	Plate	Name
19496	-----	Looper Shaft Crank.....
19447	22165	Looper Shaft Crank complete, Nos. 457AL, 1518J, 19449 and 19496.....
2049	22165	Looper Shaft Crank Pin.....
457AL	5164	Looper Shaft Crank Set Screw.....
19448	22165	Looper Shaft Crank Slide Block.....
226J	22165	Looper Shaft Crank Slide Block Cap Screw.....
12424	22165	Looper Shaft Crank Slide Block Cap Screw Washer.....
988C	22165	Looper Shaft Crank Slide Block Screw Stud.....
1518J	5169	Looper Shaft Crank Slide Block Screw Stud Nut.....
19449	-----	Looper Shaft Crank Slide Block complete, Nos. 226J, 988C, 12424 and 19448.....
18153	5169	Looper Shaft Oil Cup.....
18154	5169	Looper Shaft Oil Cup Packing.....
18098	22164	Needle Bar (hollow).....
18308	-----	Needle Bar (hollow) 18098 with 2273 and 18161.....
18301	22165	Needle Bar Connecting Link with 794E and 12384.....
794E	5170	Needle Bar Connecting Link Adjusting Screw.....
12384	22165	Needle Bar Connecting Stud with 453AL and 1904.....
1904	22165	Needle Bar Connecting Stud Roller (roller only).....
453AL	5164	Needle Bar Connecting Stud Set Screw
18231	5167	Needle Bar Crank and Thread Nipper Eccentric with 448AL and 1065AL...
20911	-----	Needle Bar Crank and Thread Nipper Eccentric 18231 and 18173.....
1065AL	5163	Needle Bar Crank and Thread Nipper Eccentric Position Screw.....
448AL	5163	Needle Bar Crank and Thread Nipper Eccentric Set Screw.....
936D	5163	Needle Bar Screw Bushing (2).....
18157	5170	Needle Bar Thread Retainer Bracket..
18350	-----	Needle Bar Thread Retainer Bracket complete, Nos. 453AL, 462AL, 12400, 18157, 18344, 18349 and 20910.....
453AL	5164	Needle Bar Thread Retainer Bracket Set Screw.....
12400	5170	Needle Bar Thread Retainer Sleeve...
18349	22169	Needle Bar Thread Retainer Spring...
20910	22165	Needle Bar Thread Retaining Collar..
18344	22165	Needle Bar Thread Retaining Stud...
462AL	5170	Needle Bar Thread Retaining Stud Set Screw.....
18161	5170	Needle Clamp with 209AL.....
2273	22165	Needle Clamp Pin.....

No.	Plate	Name
209AL	22165	Needle Set Screw.....
*18162	-----	Oscillating Rock Shaft.....
18163	-----	Oscillating Rock Shaft complete, Nos. 4784, 12388 and 18162.....
12388	22164	Oscillating Rock Shaft Hinge Pin....
878J	5163	Oscillating Rock Shaft Hinge Pin Oil Hole Stop Screw.....
12459	22170	Oscillating Rock Shaft Hinge Pin Oil Hole Stop Screw Washer (leather)..
448AL	5163	Oscillating Rock Shaft Hinge Pin Set Screw.....
4784	22170	Oscillating Rock Shaft Oil Pad.....
18164	5167	Presser Bar.....
5990	22170	Presser Bar Lifter.....
689C	22175	Presser Bar Lifter Screw.....
1520J	5164	Presser Bar Lifter Screw Nut.....
11167	22164	Presser Bar Spring (light).....
11168	22169	Presser Bar Spring Bracket with 453AL.....
453AL	5164	Presser Bar Spring Bracket Set Screw
11170	22170	Presser Bar Spring Washer.....
7309	-----	Presser Foot Cap.....
220D	22170	Presser Foot Cap Screw.....
7310	-----	Presser Foot Hinge Connection.....
106D	22169	Presser Foot Hinge Connection Hinge Screw.....
7311	22169	Presser Foot Hinge Connection Pin (2).....
62527	22169	Presser Foot Hinge Pin (2).....
20921	-----	Presser Foot Plate (left).....
20922	-----	Presser Foot Plate (right).....
20923	-----	Presser Foot Shank with 7311 (2)...
20924	-----	Presser Foot Shank Bracket.....
20925	22167	Presser Foot (hinged, compensating) complete, Nos. 106D, 220D, 7309, 7310, 20921, 20922, 20924 and two each 20923 and 62527.....
190J	5171	Presser Foot Screw.....
688W	5163	Pressure Regulating Thumb Screw...
18169	5172	Slack Thread Regulator.....
18170	5172	Slack Thread Regulator Adjusting Bracket.....
219F	5163	Slack Thread Regulator Adjusting Bracket Screw (2).....
66F	5172	Slack Thread Regulator Hinge Screw..
1521E	5171	Slack Thread Regulator Hinge Screw Nut.....
18111	5172	Slack Thread Regulator Link with 1919.....
766D	5172	Slack Thread Regulator Link Hinge Screw.....
1919	5172	Slack Thread Regulator Link Roller and Stud.....
2921	5171	Tension Disc (2).....
13889	5171	Tension Disc Steady Pin.....

No.	Plate	Name
1560C	22170	Tension Regulating Thumb Nut.....
1046C	5171	Tension Screw Stud.....
20914	-----	Tension Screw Stud 1046C with 1560C.
8238	22170	Tension Spring.....
18172	5171	Thread Eyelet (top of arm).....
145E	5169	Thread Nipper Connection Cap Screw (2).....
18175	-----	Thread Nipper Connection Rod.....
2532	5171	Thread Nipper Connection Rod Dowel Pin.....
18173	5171	Thread Nipper Connection complete, Nos. 2532, 18175 and two 145E.....
18177	5171	Thread Nipper Connection Sleeve.....
18180	5171	Thread Nipper Plate with 13589.....
18181	5171	Thread Nipper Plate Stud and Thread Eyelet.....
175F	5171	Thread Nipper Plate Stud and Thread Eyelet Set Screw.....
18182	5171	Thread Nipper Plate Washer.....
1521J	5171	Thread Nipper Regulating Nut.....
1521J	5171	Thread Nipper Regulating Nut Lock Nut.....
18187	5170	Thread Take-up Crank.....
3094	5170	Thread Take-up Crank Wedge.....
*5750	-----	Thread Take-up Crank Wedge 3094 with 690E.....
690E	5170	Thread Take-up Crank Wedge Screw....
18188	5170	Thread Take-up Lever.....
18189	5170	Thread Take-up Lever Arm.....
11204	5170	Thread Take-up Lever Hinge Pin.....
430C	5170	Thread Take-up Lever Hinge Pin Set Screw.....
18190	5170	Thread Take-up Lever Link.....
775E	5170	Thread Take-up Lever Link Cap Screw.
20995	22170	Thread Take-up Lever Rivet (2).....
18192	-----	Thread Take-up Lever complete, Nos. 18188, 18189 and two 20995.....
18323	-----	Thread Take-up Lever 18192 with 775E 11204, 18187 and 18190.....
120376	22168	Throat Plate with 335D and 18149, for single thread, for 120371.....
20917	22172	Throat Plate with 335D and 18149 for single thread for 20916.....
742F	5171	Throat Plate Screw (2).....
139637	22176	Drip Pan with four 1 in. wire nails.
*15404	-----	Trade Mark.....
15405	-----	Trade Mark Rivet (2).....

## LIST OF PARTS COMPLETE

FOR



## MACHINE No. 55-6

For Stitching Tickets on Clothing. Length of  
stitch  $2\frac{2}{3}$  to  $6\frac{1}{3}$  to the inch. One needle, One  
looper. Single thread chain stitch. Speed 1500.

No.	Plate	Name
*18327	-----	Arm with 15404 and two 15405.....
8582	22162	Arm Dowel Pin.....
12453	22162	Arm Oil Tube, for intermediate bearing.....
12454	22162	Arm Oil Tube with 132590 for oiling 18189.....
11119	5170	Arm Oil Tube with 52045 for oiling 18190 and 18231.....
52045	22162	Arm Oil Tube Packing (cotton) for 11119.....
132590	22162	Arm Oil Tube Packing (wick) for 12454.....
748E	5163	Arm Screw (back) (2).....
854E	5163	Arm Screw (front) (2).....
18328	22163	Arm Shaft.....
20908	-----	Arm Shaft 18328 with 5570 and 20911.

From the library of: Diamond Needle Corp

No.	Plate	Name
18329	5240	Arm Shaft Flanged Bushing (back)....
448AL	5163	Arm Shaft Flanged Bushing Set Screw (2).....
1069D	5164	Arm Shaft Screw.....
12480	22162	Arm Side Cap.....
219J	5163	Arm Side Cap Screw.....
12193	22164	Arm Side Cover.....
51224W	22162	Arm Side Cover Thumb Screw.....
*20915	-----	Bed.....
18133	5172	Bed Oil Hole Cover.....
1044E	5172	Bed Oil Hole Cover Hinge Screw.....
18498	22163	Belt Cover.....
18331	22164	Belt Cover Bracket with 871E and 43585.....
871E	5164	Belt Cover Bracket Screw Stud.....
43585	22169	Belt Cover Bracket Stud.....
217D	5164	Belt Cover Screw (2).....
18134	5168	Cloth Plate.....
18317	-----	Cloth Plate 18134 with 1044E and 18133.....
691F	5163	Cloth Plate Screw (3).....
20197	22164	Crank Connecting Rod with two 896AL.
896AL	5163	Crank Connecting Rod Cap Screw (2)..
908C	5163	Crank Connecting Rod Hinge Screw....
1619E	5164	Crank Connecting Rod Hinge Screw Nut
18135	-----	Face Plate.....
18136	5167	Face Plate complete, Nos. 66F, 1521E 18135, 18169, 18170, and two 219F.
190J	5171	Face Plate Screw.....
51224W	22162	Face Plate Thumb Screw.....
20913	5240	Feed Bar with 176J.....
176J	22165	Feed Bar Adjusting Screw.....
1045C	5169	Feed Bar Hinge Screw.....
1518J	5169	Feed Bar Hinge Screw Nut.....
313C	5163	Feed Bar Screw Center (2).....
56813	-----	Feed Bar Screw Center 313C with 1519J (2).....
1519J	5164	Feed Bar Screw Center Nut (2).....
18332	22168	Feed Dog, for 18342.....
898J	22165	Feed Dog Screw.....
5570	22165	Feed Eccentric with 446AL.....
18141	5167	Feed Eccentric Connecting Rod with 896AL and two 145E.....
20901	-----	Feed Eccentric Connecting Rod 18141 with 389F, 697C and 11137.....
896AL	5163	Feed Eccentric Connecting Rod Adjust- ing Screw.....
145E	5169	Feed Eccentric Connecting Rod Cap Screw (2).....
697C	5169	Feed Eccentric Connecting Rod Stud..
389F	5169	Feed Eccentric Connecting Rod Stud Cap Screw.....
11137	5169	Feed Eccentric Connecting Rod Stud Cap Screw Washer.....
1518J	5169	Feed Eccentric Connecting Rod Stud Nut.....

No.	Plate	Name
2018	5169	Feed Eccentric Connecting Rod Stud Nut Washer.....
446AL	5163	Feed Eccentric Set Screw.....
18142	5169	Feed Lifting Eccentric with 446AL...
18143	5169	Feed Lifting Eccentric Connection...
18144	5169	Feed Lifting Eccentric Oil Pad.....
446AL	5163	Feed Lifting Eccentric Set Screw....
18145	22163	Feed Rock Shaft.....
20904	-----	Feed Rock Shaft 18145 with 18146 to 18148.....
18146	5169	Feed Rock Shaft Regulator Crank with 790C and two 1147AL.....
790C	5169	Feed Rock Shaft Regulator Crank Position Screw.....
1147AL	5169	Feed Rock Shaft Regulator Crank Set Screw (2).....
307C	5163	Feed Rock Shaft Screw Center (2)....
56814	-----	Feed Rock Shaft Screw Center 307C with 1513J (2).....
1513J	5164	Feed Rock Shaft Screw Center Nut (2)
18147	5169	Feed Rock Shaft Screw Center Oil Tube (crank end).....
18148	5169	Feed Rock Shaft Screw Center Oil Tube (feed bar end).....
18149	5176	Loop Retainer, for single thread....
335D	5176	Loop Retainer Screw.....
18300	22166	Looper with 1120AL and 1389F, for single thread.....
1389F	22165	Looper Position Screw.....
1120AL	22165	Looper Set Screw.....
18152	22163	Looper Shaft.....
18319	-----	Looper Shaft 18152 with 18142, 18143, 18183 and 19447.....
19496	-----	Looper Shaft Crank.....
19447	22165	Looper Shaft Crank complete, Nos. 457AL, 1518J, 19449 and 19496.....
2049	22165	Looper Shaft Crank Pin.....
457AL	5164	Looper Shaft Crank Set Screw.....
19448	22165	Looper Shaft Crank Slide Block.....
226J	22165	Looper Shaft Crank Slide Block Cap Screw.....
12424	22165	Looper Shaft Crank Slide Block Cap Screw Washer.....
988C	22165	Looper Shaft Crank Slide Block Screw Stud.....
1518J	5169	Looper Shaft Crank Slide Block Screw Stud Nut.....
19449	-----	Looper Shaft Crank Slide Block com- plete, Nos. 226J, 988C, 12424 and 19448.....
18153	5169	Looper Shaft Oil Cup.....
18154	5169	Looper Shaft Oil Cup Packing.....
18098	22164	Needle Bar (hollow).....
18308	-----	Needle Bar (hollow) 18098 with 2273 and 18161.....

No.	Plate	Name
18301	22165	Needle Bar Connecting Link with 794E and 12384.....
794E	5170	Needle Bar Connecting Link Adjusting Screw.....
12384	22165	Needle Bar Connecting Stud with 453AL and 1904.....
1904	22165	Needle Bar Connecting Stud Roller (roller only).....
453AL	5164	Needle Bar Connecting Stud Set Screw
18231	5167	Needle Bar Crank and Thread Nipper Eccentric with 448AL and 1065AL...
20911	-----	Needle Bar Crank and Thread Nipper Eccentric 18231 with 18173.....
1065AL	5163	Needle Bar Crank and Thread Nipper Eccentric Position Screw.....
448AL	5163	Needle Bar Crank and Thread Nipper Eccentric Set Screw.....
936D	5163	Needle Bar Screw Bushing (2).....
18157	5170	Needle Bar Thread Retainer Bracket..
18350	-----	Needle Bar Thread Retainer Bracket complete, Nos. 453AL, 462AL, 12400, 18157, 18344, 18349 and 20910.....
453AL	5164	Needle Bar Thread Retainer Bracket Set Screw.....
12400	5170	Needle Bar Thread Retainer Sleeve...
18349	22169	Needle Bar Thread Retainer Spring...
20910	22165	Needle Bar Thread Retaining Collar..
18344	22165	Needle Bar Thread Retaining Stud....
462AL	5170	Needle Bar Thread Retaining Stud Set Screw.....
18161	5170	Needle Clamp with 209AL.....
2273	22165	Needle Clamp Pin.....
209AL	22165	Needle Set Screw.....
*18162	-----	Oscillating Rock Shaft.....
18333	-----	Oscillating Rock Shaft complete, Nos. 4784, 18162 and 18334.....
18334	5240	Oscillating Rock Shaft Hinge Pin....
878J	5163	Oscillating Rock Shaft Hinge Pin Oil Hole Stop Screw.....
12459	22170	Oscillating Rock Shaft Hinge Pin Oil Hole Stop Screw Washer (leather)..
448AL	5163	Oscillating Rock Shaft Hinge Pin Set Screw.....
4784	22170	Oscillating Rock Shaft Oil Pad.....
18164	5167	Presser Bar.....
52016	22170	Presser Bar Lifter.....
689C	22175	Presser Bar Lifter Screw.....
1520J	5164	Presser Bar Lifter Screw Nut.....
20023	22164	Presser Bar Spring (heavy).....
11168	22169	Presser Bar Spring Bracket with 453AL.....
453AL	5164	Presser Bar Spring Bracket Set Screw
11170	22170	Presser Bar Spring Washer.....
18306	22168	Presser Foot.....

No.	Plate	Name
190J	5171	Presser Foot Screw.....
668W	5163	Pressure Regulating Thumb Screw....
66085	22163	Pulley (loose).....
18335	5240	Pulley (tight) with 624AL.....
18336	-----	Pulley (tight) complete, Nos. 871E, 14263, 18335, 21615 to 21617, 21653 and two 997E.....
23668	22169	Pulley (tight) Pin.....
624AL	5164	Pulley (tight) Set Screw.....
18337	-----	Pulleys complete, Nos. 18336 and 66085.....
18169	5172	Slack Thread Regulator.....
18170	5172	Slack Thread Regulator Adjusting Bracket.....
219F	5163	Slack Thread Regulator Adjusting Bracket Screw (2).....
66F	5172	Slack Thread Regulator Hinge Screw..
1521E	5171	Slack Thread Regulator Hinge Screw Nut.....
18111	5172	Slack Thread Regulator Link with 1919.....
766D	5172	Slack Thread Regulator Link Hinge Screw.....
1919	5172	Slack Thread Regulator Link Roller and Stud.....
18338	22163	Starting Lever.....
18339	-----	Starting Lever complete, Nos. 159F, 803C, 913C, 1520E, 1638E, 14260, 14277, 18338, 18341, 21645, 21651, 43583 and two 399F.....
14260	22164	Starting Lever Belt Shifter for 18339.....
159F	5164	Starting Lever Belt Shifter Set Screw.....
18340	22163	Starting Lever Bracket.....
8582	22162	Starting Lever Bracket Dowel Pin (2)
123E	5164	Starting Lever Bracket Screw.....
18347	-----	Starting Lever Chain, 38 In. long, with two 56865.....
18348	22169	Starting Lever Chain Connection....
56865	22169	Starting Lever Chain Hook (2).....
21645	22169	Starting Lever Cushion (rawhide)....
399F	22171	Starting Lever Cushion Screw (2)....
564C	5164	Starting Lever Screw Center (2).....
1508E	5164	Starting Lever Screw Center Nut (2)..
14174	5240	Starting Lever Spring.....
803C	5164	Starting Lever Stop Screw.....
1520E	5164	Starting Lever Stop Screw Nut.....
14263	5240	Stop Cam with 21652.....
43583	5240	Stop Cam Interlocking Rod.....
18341	22171	Stop Cam Interlocking Rod Guide with 1070C.....
1070C	22171	Stop Cam Interlocking Rod Guide Set Screw.....
14277	22171	Stop Cam Interlocking Rod Guide Washer (rawhide).....



No.	Plate	Name
21651	5240	Stop Cam Interlocking Rod Spring....
913C	5164	Stop Cam Interlocking Rod Spring Regulating Thumb Screw.....
1638E	5164	Stop Cam Interlocking Rod Spring Regulating Thumb Screw Nut.....
21652	22171	Stop Cam Pin.....
21615	5240	Stop Cam Spring (long).....
21616	5240	Stop Cam Spring (short).....
21653	5240	Stop Cam Spring Cover.....
997E	5164	Stop Cam Spring Cover Screw (2)....
21617	22171	Stop Cam Spring Stop Block.....
871E	5164	Stop Cam Spring Stop Screw.....
2921	5171	Tension Disc (2).....
13589	5171	Tension Disc Steady Pin.....
1560C	22170	Tension Regulating Thumb Nut.....
1046C	5171	Tension Screw Stud.....
20914	-----	Tension Screw Stud 1046C with 1560C.
8238	22170	Tension Spring.....
18172	5171	Thread Eyelet (top of arm).....
145E	5169	Thread Nipper Connection Cap Screw (2).....
18175	-----	Thread Nipper Connection Rod.....
2532	5171	Thread Nipper Connection Rod Dowel Pin.....
18173	5171	Thread Nipper Connection complete, Nos. 2532, 18175 and two 145E.....
18177	5171	Thread Nipper Connection Sleeve....
18180	5171	Thread Nipper Plate with 13589.....
18181	5171	Thread Nipper Plate Stud and Thread Eyelet.....
175F	5171	Thread Nipper Plate Stud and Thread Eyelet Set Screw.....
18182	5171	Thread Nipper Plate Washer.....
1521J	5171	Thread Nipper Regulating Nut.....
1521J	5171	Thread Nipper Regulating Nut Lock Nut.....
18187	5170	Thread Take-up Crank.....
3094	5170	Thread Take-up Crank Wedge.....
*5750	-----	Thread Take-up Crank Wedge 3094 with 690E.....
690E	5170	Thread Take-up Crank Wedge Screw....
18188	5170	Thread Take-up Lever.....
18189	5170	Thread Take-up Lever Arm.....
11204	5170	Thread Take-up Lever Hinge Pin.....
430C	5170	Thread Take-up Lever Hinge Pin Set Screw.....
18190	5170	Thread Take-up Lever Link.....
775E	5170	Thread Take-up Lever Link Cap Screw.
20995	22170	Thread Take-up Lever Rivet (2).....
18192	-----	Thread Take-up Lever complete, Nos. 18188, 18189 and two 20995.....
18323	-----	Thread Take-up Lever 18192 with 775E 11204, 18187 and 18190.....
18342	22168	Throat Plate with 335D and 18149 for single thread, for 18332.....

No.	Plate	Name
742F	5171	Throat Plate Screw (2).....
139637	22176	Drip Pan with four 1 in. wire nails.
*15404	-----	Trade Mark.....
15405	-----	Trade Mark Rivet (2).....

SINGER Needles should be used  
in SINGER Machines.  
These Needles and their Containers  
are marked with the  
Company's Trade-Mark "SIMANCO.\*\*\*" 1

Needles in Containers marked  
"FOR SINGER MACHINES"  
are NOT **SINGER** made needles. 2

## ACCESSORIES

No.	Plate	Name
12361	22173	Machine Hinge Connection (2).....
41400	22173	Machine Rest Pin (wood).....
120344	22173	Oiler (copper plated) with 120345...
120345	22173	Oiler Spout, 4 1/2 in. long.....
26026	22173	Screw Driver (machine).....
26485	22173	Screw Driver (shuttle tension).....
120341	22173	Tweezers (curved).....
8909	22173	Wrench for 1513 and 1518.....
4822	22173	Wrench for 1521.....
8908	22173	Wrench for 1519 and 1520.....
19221	22173	Wrench for 936 and 1619.....

## EDGE FOLDERS

FOR Nos. 55-3 AND 55-4 MACHINES

No.	Plate	Name
35627	22172	Edge Folder.....
35628	22172	Edge Folder Hinge Plate.....
74D	5164	Edge Folder Hinge Screw.....
35629	22172	Edge Folder (double) swinging, complete, for burlap bags, for 55-3 Machine, Nos. 74D, 35627 and 35628
35630	22172	Edge Folder (double) on Shank, for closing burlap bags, for 55-3 Machine.....
35713	5238	Edge Folder on Shank, for 55-4 Machine.....

## FINGER GUARDS

FOR Nos. 55.3, 55.5 AND 55.6 MACHINES

No.	Plate	Name
36818	5809	Finger Guard.....
36819	5809	Finger Guard Friction Washer.....
50316J	5809	Finger Guard Hinge Screw.....
36820	5809	Finger Guard Holder with 196J.....
196J	5809	Finger Guard Holder Clamping Screw..
36821	5809	Finger Guard complete, Nos. 36818 to 36820 and 50316J.....
120496	22175	Finger Guard.....
236J	22175	Finger Guard Screw.....
120497	22175	Finger Guard Holder with 50302J....
50302J	22175	Finger Guard Holder Set Screw.....
120498	-----	Finger Guard complete, Nos. 236J, 120496 and 120497.....

## FOOT LIFTER

FOR Nos. 55.3 TO 55.5 MACHINES

No.	Plate	Name
5596	5168	Bell Crank.....
56848	-----	Bell Crank 5596 with 5599 and 5601..
5599	5168	Bell Crank Bracket.....
178E	22175	Bell Crank Bracket Screw (2).....
5601	22175	Bell Crank Hinge Pin.....
5735	22175	Bell Crank Spring.....
5598	5168	Bell Crank complete, Nos. 5735 and 56848.....
5670	-----	Chain, length 26 in. to 35 in. with 56864 and 56865.....
Note: When ordering No. 5670, state length required.		
4879	5168	Chain Connecting Link.....
56864	22175	Chain Hook (large).....
56865	22169	Chain Hook (small).....
12237	22163	Lifting Lever with 448AL.....
12415	5168	Lifting Lever Connecting Rod.....
12416	22175	Lifting Lever Connecting Rod Joint..
76D	5163	Lifting Lever Connecting Rod Joint Hinge Screw.....
1521J	5171	Lifting Lever Connecting Rod Lock Nut.....
802D	5163	Lifting Lever Hinge Screw.....
12240	22175	Lifting Lever Pin.....
448AL	5163	Lifting Lever Pin Set Screw.....
2763	819	Rock Shaft.....
12242	819	Rock Shaft Hanger with two wood screws 1 in. No. 10 F.H. (2).....
6337	819	Rock Shaft Lifting Bracket with two 356C (2).....
12243	819	Rock Shaft Lifting Bracket Hook....
7125	819	Rock Shaft Lifting Bracket Hook....
356C	5163	Rock Shaft Lifting Bracket Hook Set Screw.....
356C	5163	Rock Shaft Lifting Bracket Set Screw
2770	819	Rock Shaft Stop Dog with 140219C....
140219C	22175	Rock Shaft Stop Dog Set Screw.....
4880	819	Rock Shaft complete, Nos. 2763, 2770 7125, 12243 and two each 6327 and 12242.....
4881	819	Treadle.....
4882	5168	Treadle Shaft.....
4883	5168	Treadle Spring.....
4884	819	Treadle Stand.....
4885	819	Treadle complete, Nos. 4879, 4881 to 4884 and two wood screws 1 in. No. 16.....
18210	-----	Foot Lifter complete Nos. 76D, 802D, 1521J, 4880, 4885, 5598, 5670, 12237, 12240, 12415, 12416 and two 178E.....

## GUIDE (Adjustable, Hinged)

FOR No. 55.5 MACHINE

No.	Plate	Name
120438	22172	Guide.....
28972	22172	Guide Holder.....
35610	22171	Guide Holder Friction Washer.....
940W	22171	Guide Holder Hinge Screw.....
28973	22171	Guide Holder Shank.....
51224W	22162	Guide Thumb Screw.....
7071	22165	Guide Thumb Screw Washer.....
120439	22172	Guide (adjustable, hinged) complete, Nos. 940W, 7071, 28972, 28973, 35610, 51224W and 120438.....

## KNEE LIFTER

No.	Plate	Name
5596	5168	Bell Crank.....
56848	-----	Bell Crank 5596 with 5599 and 5601...
5599	5168	Bell Crank Bracket.....
178E	22175	Bell Crank Bracket Screw (2).....
5601	22175	Bell Crank Hinge Pin.....
5735	22175	Bell Crank Spring.....
5598	5168	Bell Crank complete, Nos. 5735 and 56848.....
12237	22163	Lifting Lever with 448AL.....
12415	5168	Lifting Lever Connecting Rod.....
12416	22175	Lifting Lever Connecting Rod Joint...
76D	5163	Lifting Lever Connecting Rod Joint Hinge Screw.....
1521J	5171	Lifting Lever Connecting Rod Lock Nut
802D	5163	Lifting Lever Hinge Screw.....
12240	22175	Lifting Lever Pin.....
448AL	5163	Lifting Lever Pin Set Screw.....
2763	819	Rock Shaft.....
139633	-----	Rock Shaft 2763 with 2770, 6337 and 139623.....
127312	22177	Rock Shaft Hanger (back) with two wood screws 1 in. No. 10 F.H.....
7539	22177	Rock Shaft Hanger (back) with two wood screws 1 in. No. 10 F.H. (2)..
12242	819	Rock Shaft Hanger (front) with two wood screws 1 in. No. 10 F.H.....
2765	22177	Rock Shaft Knee Arm.....
2766	22177	Rock Shaft Knee Arm Hub with 356C....
356C	5163	Rock Shaft Knee Arm Hub Set Screw....
2768	-----	Rock Shaft Knee Arm 2765 with 2766 and 2767.....
2767	22177	Rock Shaft Knee Plate with 356C.....
356C	5163	Rock Shaft Knee Plate Set Screw.....
6337	819	Rock Shaft Lifting Bracket with two 356C.....
139623	22177	Rock Shaft Lifting Bracket Hook.....

No.	Plate	Name
356C	5163	Rock Shaft Lifting Bracket Hook Set Screw.....
356C	5163	Rock Shaft Lifting Bracket Set Screw
2770	819	Rock Shaft Stop Dog with 140219C....
140219C	22175	Rock Shaft Stop Dog Set Screw.....
139624	22177	Rock Shaft complete, Nos. 2768, 12242, 127312 and 139633.....
139625	22177	Rock Shaft complete, Nos. 2768, 139633 and two 7539.....
20989	-----	Knee Lifter complete (power table) Nos. 76D, 802D, 1521J, 5598, 12237 12240, 12415, 12416, 139624 and two 178E.....
20990	-----	Knee Lifter complete (individual motors and foot power stands) Nos. 76D, 802D, 1521J, 5598, 12237, 12240, 12415, 12416, 139625 and two 178E.....

## LAP SEAM GUIDE ON SHANK

FOR No. 55.4 MACHINE

No.	Plate	Name
35714	5238	Lap Seam Guide on Shank, for canvas work.....

## MACHINE BASE

No.	Plate	Name
19219	22174	Bed Frame Cushion (leather) (4).....
158C	22174	Bed Frame Cushion Screw (8).....
19220	22174	Bed Frame Cushion Spring (4).....
19226	22174	Bed Frame Hinge Connection (2).....
19397	22174	Bed Frame Hinge Connection Cap (2)..
211F	22174	Bed Frame Hinge Connection Cap Screw (2).....
19398	-----	Bed Frame Hinge Connection 19226 with 211F and 19397 (2).....
16555	22174	Bed Frame Hinge Plate (2).....
14010	22174	Bed Frame Hinge Plate Rivet (6).....
20067	819	Bed Frame with two each 16555, 19398 four each 19219, 19220, six each 14010 wood screws 1 1/4 in. No. 12 and eight 158C.....

## TAPE HOLDERS

## TAPE HOLDER

(8 INCH DISC)

No.	Plate	Name
26061	989	Bracket Wire with Disc.....
26062	989	Disc (adjustable) with 51224J and 35925.....
35925	-----	Disc Hub.....
51224J	22162	Disc Thumb Screw.....
26325	22172	Foot with 736D and three wood screws 1 in. No. 12.....
736D	5163	Foot Screw.....
26063	989	Tape Holder complete, Nos. 26061 and 26062.....
26065	-----	Tape Holder with Foot complete, Nos. 26063 and 26325.....

## TAPE HOLDER

(10 INCH DISC)

No.	Plate	Name
26066	989	Bracket Wire.....
26067	-----	Bracket Wire complete, Nos. 26066, 26068 and 26072.....
26068	989	Disc.....
26069	989	Disc Hub.....
26071	-----	Disc complete, Nos. 26068 and 26069.
26064	22172	Foot with 736D and three wood screws 1 in. No. 12.....
736D	5163	Foot Screw.....
26072	989	Tape Guide.....
26073	22174	Tension Adjusting Collar with 51224W
51224W	22162	Tension Adjusting Collar Thumb Screw
13211	22174	Tension Adjusting Spring.....
26074	989	Tape Holder complete, Nos. 13211, 26067, 26071 and 26073.....
26343	-----	Tape Holder with Foot complete, Nos. 26064 and 26074.....

## THREAD UNWINDERS

## THREAD UNWINDER

FOR No. 55.3 MACHINE

FOR THREE SPOOLS OR THREE LARGE CONES OF THREAD

No.	Plate	Name
225259	22178	Spool Rest (for one spool) with 201018C.....
225257	22178	Spool Rest (for two spools) with 201018C.....
150203	22178	Spool Rest Cushion (felt) (3).....
225388	22178	Spool Rest Rod.....
200383C	22174	Spool Rest Rod Set Screw.....
201018C	22174	Spool Rest Set Screw (2).....
259658	22178	Spool Stand with 200383C.....
225391	22178	Thread Guide (3).....
201696J	22174	Thread Guide Lock Nut.....
225326	22174	Thread Guide Position Cup.....
225324	22178	Thread Guide Rod with 208AL and 225322.....
208AL	5164	Thread Guide Rod Screw.....
225322	22174	Thread Guide Rod Washer.....
259143	22178	Thread Unwinder complete, Nos. 201696J, 225257, 225259, 225324, 225326, 225388, 259658 three each 150203, 225391 and wood screws 7/8 in. No. 12.....
27739	7234	Thread Cone (wood) for large cones.
225390	7234	Thread Cone Holder, for inverted cones.....

Note: No. 225390 is use with, but not in-  
cluded in 259143.

## THREAD UNWINDER

FOR No. 55.4 MACHINE

FOR FOUR SPOOLS OR FOUR LARGE CONES OF THREAD

No.	Plate	Name
225257	22179	Spool Rest with 201018C.....
150203	22179	Spool Rest Cushion (felt) (4).....
225388	22179	Spool Rest Rod.....
200383C	22174	Spool Rest Rod Set Screw.....
201018C	22174	Spool Rest Set Screw.....
259658	22179	Spool Stand with 200383C.....
225391	22179	Thread Guide (4).....
201696J	22174	Thread Guide Lock Nut.....

No.	Plate	Name
225326	22174	Thread Guide Position Cup.....
225324	22179	Thread Guide Rod with 208AL and 225322.....
208AL	5164	Thread Guide Rod Screw.....
225322	22174	Thread Guide Rod Washer.....
259144	22179	Thread Unwinder complete, Nos. 201696J, 225324, 225326, 225388, 259658, two 225257, three wood screws 7/8 in. No. 12, four each 150203 and 225391.....
27739	7234	Thread Cone (wood) for large cones.
225390	7234	Thread Cone Holder for inverted cones.....

Note: Nos. 27739 and 225390 are use with,  
but not included in 259144.

## THREAD UNWINDER

FOR No. 55.5 MACHINE

FOR TWO SPOOLS OR TWO LARGE CONES OF THREAD

No.	Plate	Name
225257	22180	Spool Rest with 201018C.....
150203	22180	Spool Rest Cushion (felt) (2).....
225388	22180	Spool Rest Rod.....
200383C	22174	Spool Rest Rod Set Screw.....
201018C	22174	Spool Rest Set Screw.....
259658	22180	Spool Stand with 200383C.....
225391	22180	Thread Guide (2).....
201696J	22174	Thread Guide Lock Nut.....
225326	22174	Thread Guide Position Cup.....
225324	22180	Thread Guide Rod with 208AL and 225322.....
208AL	5164	Thread Guide Rod Screw.....
225322	22174	Thread Guide Rod Washer.....
225258	22180	Thread Unwinder complete, Nos. 201696J, 225257, 225324, 225326, 225388, 259658, two each 150203, 225391 and three wood screws 7/8 in. No. 12 F.H.....
27739	7234	Thread Cone (wood) for large cones.
225390	7234	Thread Cone Holder for inverted cones.....

Note: Nos. 27739 and 225390 are used with,  
but not included in 225258.

## THREAD UNWINDER

FOR No. 55.6 MACHINE

FOR ONE SPOOL OR ONE LARGE CONE OF THREAD

No.	Plate	Name
225259	22181	Spool Rest with 201018C.....
150203	22181	Spool Rest Cushion (felt).....
225388	22181	Spool Rest Rod.....
200383C	22174	Spool Rest Rod Set Screw.....
201018C	22174	Spool Rest Set Screw.....
259658	22181	Spool Stand with 200383C.....
225391	22181	Thread Guide.....
201696J	22174	Thread Guide Lock Nut.....
225326	22174	Thread Guide Position Cup.....
225324	22181	Thread Guide Rod with 208AL and 225322.....
208AL	5164	Thread Guide Rod Screw.....
225322	22174	Thread Guide Rod Washer.....
225260	22181	Thread Unwinder complete, Nos. 150203, 201696J, 225259, 225324, 225326, 225388, 225391, 259658 and three wood screws 7/8 in. No. 12 F.H.....
27739	7234	Thread Cone (wood) for large cones.
225390	7234	Thread Cone Holder for inverted cones.....

Note: Nos. 27739 and 225390 are used with,  
but not included in 225260.

## NUMERICAL LIST OF PARTS

No.	Plate	Name
66F	5172	Slack Thread Regulator Hinge Screw for 18136 and 18274.....
74D	5164	Edge Folder Hinge Screw for 35629...
76D	5163	Lifting Lever Connecting Rod Joint Hinge Screw for 18210, 20989 and 20990.....
106D	22169	Presser Foot Hinge Connection Hinge Screw for 20925.....
123E	5164	Starting Lever Bracket Screw for 55-6 Machine.....
144D	5163	Arm Shaft Screw for 55-3 to 55-5 Machines.....
145E	5169	Feed Eccentric Connecting Rod Cap Screw for 18141 and 20927 (2).....
145E	5169	Thread Nipper Connection Cap Screw for 18173 (2).....
145E	5169	Thread (upper) Nipper Connection Cap Screw for 18173.....
158C	22174	Bed Frame Cushion Screw for 20067 (8).....
159F	5164	Starting Lever Belt Shifter Set Screw for 18339.....
175F	5171	Thread Nipper Plate Stud and Thread Eyelet Set Screw for 55-5 and 55-6 Machines.....
175F	5171	Thread (upper) Nipper Plate Stud and Thread Eyelet Set Screw for 55-3 and 55-4 Machines.....
176J	22165	Feed Bar Adjusting Screw for 20913..
178E	22175	Bell Crank Bracket Screw for 18210, 20989 and 20990 (2).....
184E	22171	Guide Screw Stud for 55-5 Machine...
190J	5171	Face Plate Screw.....
190J	5171	Guide Screw for 55-3 and 55-4 Machines.....
190J	5171	Guide Adjusting Screw for 55-5 Machine.....
190J	5171	Presser Foot Screw.....
190J	5171	Thread (under) Take-up Eyelet Screw for 55-3 and 55-4 Machines.....
191C	5171	Thread (under) Eyelet Screw for 55-3 and 55-4 Machines.....
196J	5809	Finger Guard Holder Clamping Screw for 36820.....
208AL	5164	Thread Unwinder Thread Guide Rod Screw for 225324.....
209AL	22165	Needle Set Screw for 18052 and 18161
210J	22162	Balance Wheel Oil Cover Screw for 55-3 and 55-4 Machines.....

From the library of: Diamond Needle Corp

## NUMERICAL LIST OF PARTS

No.	Plate	Name
211F	22174	Bed Frame Hinge Connection Cap Screw for 19398 (2).....
217D	5164	Belt Cover Screw for 55-6 Machine (2).....
219F	5163	Slack Thread Regulator Adjusting Bracket Screw for 18136 and 18274 (2).....
219J	5163	Arm Side Cap Screw.....
220D	22170	Presser Foot Cap Screw for 20925....
226J	22165	Looper Shaft Crank Slide Block Cap Screw for 19449.....
236J	22175	Finger Guard Screw for 120498.....
248AL	5163	Clamp Stop Motion Clamp Stop Screw for 3022.....
256J	22162	Clamp Stop Motion Clamp Screw for 3022 and 56827.....
307C	5163	Feed Rock Shaft Screw Center for 56814 (2).....
313C	5163	Feed Bar Screw Center for 56813 (2)..
335D	5176	Loop Retainer Screw for 18194, 18214, 18217, 18219, 18287, 18290, 18293, 18342, 20917 and 120376.....
356C	5163	Rock Shaft Lifting Bracket Hook Set Screw for 6337.....
356C	5163	Rock Shaft Lifting Bracket Set Screw for 6337.....
356C	5163	Rock Shaft Knee Arm Hub Set Screw for 2766.....
356C	5163	Rock Shaft Knee Plate Set Screw for 2767.....
389F	5169	Feed Eccentric Connecting Rod Stud Cap Screw for 20901 and 20928.....
399F	22171	Starting Lever Cushion Screw for 18339 (2).....
430C	5170	Thread Take-up Lever Hinge Pin Set Screw for 55-5 and 55-6 Machines..
430C	5170	Thread (upper) Take-up Lever Hinge Pin Set Screw for 55-3 and 55-4 Machines.....
435AL	22162	Balance Wheel Set Screw for 56899 (2).....
446AL	5163	Feed Eccentric Set Screw for 5570....
446AL	5163	Feed Lifting Eccentric Set Screw for 18142.....
448AL	5163	Arm Shaft Flanged Bushing Set Screw (2).....
448AL	5163	Balance Wheel Set Screw for 4370 and 4388 (2).....
448AL	5163	Feed Eccentric Set Screw for 18309 (2).....
448AL	5163	Needle Bar Crank and Thread Nipper Eccentric Set Screw for 18231.....
448AL	5163	Oscillating Rock Shaft Hinge Pin Set Screw.....
448AL	5163	Lifting Lever Pin Set Screw for 12237.....

## NUMERICAL LIST OF PARTS

No.	Plate	Name
453AL	5164	Needle Bar Connecting Stud Set Screw for 12384.....
453AL	5164	Needle Bar Thread Retainer Bracket Set Screw for 18343, 18345 and 18350.....
453AL	5164	Presser Bar Spring Bracket Set Screw for 11168 and 20926.....
453AL	5164	Thread (under) Take-up Body Set Screw for 18185.....
457AL	5164	Looper Shaft Crank Set Screw for 19447.....
462AL	5170	Clamp Stop Motion Flanged Bushing Set Screw for 4933 (2).....
462AL	5170	Needle Bar Thread Retaining Stud Set Screw for 18343, 18345 and 18350..
564C	5164	Starting Lever Screw Center for 55-6 Machine (2).....
624AL	5164	Pulley (tight) Set Screw for 18335..
686E	5171	Tension (under thread) Screw Stud for 58590.....
688W	5163	Pressure Regulating Thumb Screw.....
689C	22175	Presser Bar Lifter Screw.....
690E	5170	Thread Take-up Crank Wedge Screw for 5750.....
690E	5170	Thread (upper) Take-up Crank Wedge Screw for 5750.....
691F	5163	Cloth Plate Screw (3).....
697C	5169	Feed Eccentric Connecting Rod Stud for 20901 and 20928.....
736D	5163	Tape Holder Foot Screw for 26064 and 26325.....
742F	5171	Throat Plate Screw (2).....
748E	5163	Arm Screw (back) (2).....
766D	5172	Slack Thread Regulator Link Hinge Screw.....
775E	5170	Thread Take-up Lever Link Cap Screw for 18323.....
775E	5170	Thread (upper) Take-up Lever Link Cap Screw for 18323 and 18324.....
790C	5169	Feed Rock Shaft Regulator Crank Position Screw for 18146.....
794E	5170	Needle Bar Connecting Link Adjusting Screw for 18301.....
802D	5163	Lifting Lever Hinge Screw for 18210, 20989 and 20990.....
803C	5164	Starting Lever Stop Screw for 18339..
854E	5163	Arm Screw (front) (2).....
871E	5164	Belt Cover Bracket Screw Stud for 18331.....
871E	5164	Stop Cam Spring Stop Screw for 18336
878J	5163	Oscillating Rock Shaft Hinge Pin Oil Hole Stop Screw
889AL	5180	Presser Foot Spring Adjusting Screw for 18168, 18213 and 18282.....

## NUMERICAL LIST OF PARTS

No.	Plate	Name
896AL	5163	Crank Connecting Rod Cap Screw for 20197 (2).....
896AL	5163	Feed Eccentric Connecting Rod Adjusting Screw for 18141 and 20927.....
898J	22165	Feed Dog Screw.....
908C	5163	Crank Connecting Rod Hinge Screw.....
913C	5164	Stop Cam Interlocking Rod Spring Regulating Thumb Screw for 18339....
936D	5163	Needle Bar Screw Bushing (2).....
940W	22171	Guide Holder Hinge Screw for 120373, 120428 and 120439.....
988C	22165	Looper Shaft Crank Slide Block Screw Stud for 19449.....
997E	5164	Stop Cam Spring Cover Screw for 18336 (2).....
1044E	5172	Bed Oil Hole Cover Hinge Screw for 18317.....
1045C	5169	Feed Bar Hinge Screw.....
1046C	5171	Tension Screw Stud for 20914.....
1046C	5171	Tension (upper thread) Screw Stud for 20914.....
1065AL	5163	Needle Bar Crank and Thread Nipper Eccentric Position Screw for 18231.....
1069D	5164	Arm Shaft Screw for 55-6 Machine.....
1070C	22171	Stop Cam Interlocking Rod Guide Set Screw for 18341.....
1076C	22170	Looper Set Screw for 18119 and 18120.....
1120AL	22165	Looper Set Screw for 18299 and 18300.....
1147AL	5169	Feed Rock Shaft Regulator Crank Set Screw for 18146 (2).....
1389F	22165	Looper Position Screw for 18299 and 18300.....
1508E	5164	Starting Lever Screw Center Nut for 55-6 Machine (2).....
1513J	5164	Feed Rock Shaft Screw Center Nut for 56814 (2).....
1518J	5169	Feed Bar Hinge Screw Nut.....
1518J	5169	Feed Eccentric Connecting Rod Stud Nut.....
1518J	5169	Looper Shaft Crank Slide Block Screw Stud Nut for 19447.....
1519J	5164	Feed Bar Screw Center Nut for 56813 (2).....
1520E	5164	Starting Lever Stop Screw Nut for 18339.....
1520J	5164	Presser Bar Lifter Screw Nut.....
1521J	5171	Lifting Lever Connecting Rod Lock Nut for 18210, 20989 and 20990.....
1521E	5171	Slack Thread Regulator Hinge Screw Nut for 18136 and 18274.....
1521J	5171	Thread (upper) Nipper Regulating Nut for 55-3 and 55-4 Machines.....
1521J	5171	Thread (upper) Nipper Regulating Nut Lock Nut for 55-3 and 55-4 Machines.....
1521J	5171	Thread Nipper Regulating Nut for 55-5 and 55-6 Machines.....

## NUMERICAL LIST OF PARTS

No.	Plate	Name
1521J	5171	Thread Nipper Regulating Nut Lock Nut for 55-5 and 55-6 Machines.....
1560C	22170	Tension (under thread) Regulating Thumb Nut for 58590.....
1560C	22170	Tension (upper thread) Regulating Thumb Nut for 20914 for 55-3 and 55-4 Machines.....
1560C	22170	Tension Regulating Thumb Nut for 20914 for 55-5 and 55-6 Machines....
1619E	5164	Crank Connecting Rod Hinge Screw Nut.....
1638E	5164	Stop Cam Interlocking Rod Spring Regulating Thumb Screw Nut for 18339.....
1904	22165	Needle Bar Connecting Stud Roller (roller only) for 12384.....
1919	5172	Slack Thread Regulator Link Roller and Stud for 18111.....
2018	5169	Feed Eccentric Connecting Rod Stud Nut Washer.....
2020	22162	Clamp Stop Motion Clamp Washer for 3022.....
2022	-----	Clamp Stop Motion Flanged Bushing Pin for 55-4 Machine.....
2049	22165	Looper Shaft Crank Pin.....
2102	22170	Tension (under thread) Disc (2).....
2135	5150	Balance Wheel (stand) heavy rim 2 1/2 in. pulley for 3022, for 55-4 Machines.....
2273	22165	Needle Clamp Pin for 18308 and 18314.....
2532	5171	Thread Nipper Connection Rod Dowel Pin for 18173.....
2532	5171	Thread (upper) Nipper Connection Rod Dowel Pin for 18173.....
2763	819	Rock Shaft for 4880 and 139633.....
2765	22177	Rock Shaft Knee Arm for 2768.....
2766	22177	Rock Shaft Knee Arm Hub with 356C for 2768.....
2767	22177	Rock Shaft Knee Plate with 356C for 2768.....
2768	-----	Rock Shaft Knee Arm 2765 with 2766 and 2767 for 139624 and 139625.....
2770	819	Rock Shaft Stop Dog with 140219C for 4880 and 139633.....
2862	5150	Balance Wheel (stand) heavy rim 3 in. pulley for 3022, for 55-4 Machine..
2921	5171	Tension Disc for 55-5 and 55-6 Machines (2).....
2921	5171	Tension (upper thread) Disc for 55-3 and 55-4 Machines (2).....
3022	-----	Clamp Stop Motion complete for 55-4 Machine, Nos. 248AL, 256J, 2020 and 4933.....
*3023	-----	Clamp Stop Motion Flanged Bushing for 4933 and 56827.....
3094	5170	Thread Take-up Crank Wedge for 5750..

Diamond Needle Corp.



No.	Plate	Name
3094	5170	Thread (upper) Take-up Crank Wedge for 5750.....
4370	5150	Balance Wheel (stand) heavy rim, 2 3/4 in. pulley with two 448AL, for 55-3 and 55-4 Machines.....
4388	5150	Balance Wheel (power) light rim, 2 3/4 in. pulley with two 448AL, for 55-3 to 55-5 Machines.....
4784	22170	Oscillating Rock Shaft Oil Pad for 18163 and 18333.....
4822	22173	Wrench for 1521 (Accessories).....
4879	5168	Foot Lifter Chain Connecting Link for 4885.....
4880	819	Rock Shaft complete for 18210, Nos. 2763, 2770, 7125, 12243 and two each 6337 and 12242.....
4881	819	Foot Lifter Treadle for 4885.....
4882	5168	Foot Lifter Treadle Shaft for 4885..
4883	5168	Foot Lifter Treadle Spring for 4885.
4884	819	Foot Lifter Treadle Stand for 4885..
4885	819	Foot Lifter Treadle complete for 18210, Nos. 4879, 4881 to 4884 and two wood screws 1 in. No. 16.....
4933	-----	Clamp Stop Motion Flanged Bushing 3023 with two 462AL, for 3022.....
5570	22165	Feed Eccentric with 446AL for 20905 and 20908.....
5596	5168	Bell Crank for 56848.....
5598	5168	Bell Crank complete for 18210, 20989 and 20990 Nos. 5735 and 56848.....
5599	5168	Bell Crank Bracket for 56848.....
5601	22175	Bell Crank Hinge Pin for 56848.....
5670	-----	Foot Lifter Chain length 26 in. to 35 in. with 56864 and 56865 for 18210.....
		Note: When ordering No. 5670 state length required.
5735	22175	Bell Crank Spring for 5598.....
*5750	-----	Thread Take-up Crank Wedge 3094 with 690E for 55-5 and 55-6 Machines...
*5750	-----	Thread (upper) Take-up Crank Wedge 3094 with 690E for 55-3 and 55-4 Machines.....
5990	22170	Presser Bar Lifter for 55-5 Machine.
6337	819	Rock Shaft Lifting Bracket with two 356C, for 4880 and 139633 (2).....
7071	22165	Guide Adjusting Screw Washer for 55-5 Machine.....
7071	22165	Guide Screw Washer for 55-3 and 55-4 Machines.....
7071	22165	Guide Thumb Screw Washer for 120373, 120428 and 120439.....
7125	819	Rock Shaft Lifting Bracket Hook for 4880.....
7309	-----	Presser Foot Cap for 20925.....

No.	Plate	Name
7310	-----	Presser Foot Hinge Connection for 20925.....
7311	22169	Presser Foot Hinge Connection Pin for 20923 (2).....
7539	22177	Rock Shaft Hanger (back) with two wood screws 1 in. No. 10 F.H. for 139625 (2).....
8238	22170	Tension Spring for 55-5 and 55-6 Machines.....
8238	22170	Tension (upper thread) Spring for 55-3 and 55-4 Machines.....
8582	22162	Arm Dowel Pin.....
8582	22162	Starting Lever Bracket Dowel Pin for 55-6 Machine (2).....
8908	22173	Wrench for 1519 and 1520 (Accessories).....
8909	22173	Wrench for 1513 and 1518 (Accessories).....
9525	5171	Thread (under) Eyelet Screw Washer for 55-3 and 55-4 Machines.....
10148	5171	Tension (under thread) Spring for 55-3 and 55-4 Machines.....
11119	5170	Arm Oil Tube with 52045 for oiling; 18190 and 18231.....
11137	5169	Feed Eccentric Connecting Rod Stud Cap Screw Washer for 20901 and 20928.....
11167	22164	Presser Bar Spring (light) for 55-3 to 55-5 Machines.....
		Note: No. 11167 is sent with 55-3, 55-4 and 55-5 Machines unless another spring is specified on order.
11168	22169	Presser Bar Spring Bracket with 453AL for 55-4, 55-5 and 55-6 Machines.....
11170	22170	Presser Bar Spring Washer.....
11204	5170	Thread Take-up Lever Hinge Pin for 18323.....
11204	5170	Thread (upper) Take-up Lever Hinge Pin for 18323 and 18324.....
12139	22164	Presser Bar Spring (medium) for 55-3 and 55-4 Machines.....
12193	22164	Arm Side Cover.....
12237	22163	Lifting Lever with 448AL, for 18210, 20989 and 20990.....
12240	22175	Lifting Lever Pin for 18210, 20989 and 20990.....
12242	819	Rock Shaft Hanger with two wood screws 1 in. No. 10 F.H. for 4880 (2).....
12242	819	Rock Shaft Hanger (front) with two wood screws 1 in. No. 10 F.H. for 139624.....
12243	819	Rock Shaft Lifting Bracket Hook for 4880.....

## NUMERICAL LIST OF PARTS

No.	Plate	Name
12357	22162	Arm Shaft Flanged Bushing (back) for 55-3 to 55-5 Machines.....
12361	22173	Machine Hinge Connection (Accessories) (2).....
12384	22165	Needle Bar Connecting Stud with 453AL and 1904 for 18301.....
12388	22164	Oscillating Rock Shaft Hinge Pin for 18163.....
12400	5170	Needle Bar Thread Retainer Sleeve for 18343, 18345 and 18350.....
12415	5168	Lifting Lever Connecting Rod for 18210, 20989 and 20990.....
12416	22175	Lifting Lever Connecting Rod Joint for 18210, 20989 and 20990.....
12424	22165	Looper Shaft Crank Slide Block Cap Screw Washer for 19449.....
12453	22162	Arm Oil Tube, for intermediate bearing.....
12454	22162	Arm Oil Tube with 132590 for oiling 18189.....
12459	22170	Oscillating Rock Shaft Hinge Pin Oil Hole Stop Screw Washer (leather)..
12480	22162	Arm Side Cap.....
13211	22174	Tape Holder Tension Adjusting Spring for 26074.....
13550	22169	Tension (under thread) Separating Disc for 55-4 Machine.....
13550	22169	Thread (upper) Nipper Separating Disc for 55-4 Machine.....
13589	5171	Tension Disc Steady Pin for 18180...
13589	5171	Tension (upper thread) Disc Steady Pin for 18180.....
14010	22174	Bed Frame Hinge Plate Rivet for 20067 (6).....
14174	5240	Starting Lever Spring for 55-6 Machine.....
14260	22164	Starting Lever Belt Shifter for 18339.....
14263	5240	Stop Cam with 21652 for 18336.....
14277	22171	Stop Cam Interlocking Rod Guide Washer (rawhide) for 18339.....
*15404	-----	Trade Mark for 18129, 18272 and 18327.....
15405	-----	Trade Mark Rivet for 18129, 18272 and 18327 (2).....
16555	22174	Bed Frame Hinge Plate for 20067 (2).
18052	5172	Needle Clamp with two 209AL for 18314.....
		Note: When ordering No. 18052, state gauge required.
18055	22170	Presser Foot Hinge Pin for 18197....
18098	22164	Needle Bar (hollow) for 18308 and 18314.....
18111	5172	Slack Thread Regulator Link with 1919.....

## NUMERICAL LIST OF PARTS

No.	Plate	Name
18119	22166	Looper (inside) with 1076C for No. 23 needle, for 13/64 in. gauge and above for 55-4 Machine.....
18120	22166	Looper (outside) with 1076C for No. 23 needle, for 13/64 in. gauge and above, for 55-4 Machine.....
*18129	-----	Arm with 15404 and two 15405, for 55-3 and 55-5 Machines.....
18131	22163	Arm Shaft for 20905 and 20907.....
18133	5172	Bed Oil Hole Cover for 18317.....
18134	5168	Cloth Plate for 18317.....
18135	-----	Face Plate for 18136.....
18136	5167	Face Plate complete for 55-3, 55-5 and 55-6 Machines Nos. 66F, 1521E, 18135, 18169, 18170 and two 219F..
18140	5175	Feed Dog, 17 teeth (12 teeth to the inch) for 18193 and 18194 for 55-3 Machine.....
18141	5167	Feed Eccentric Connecting Rod with 896AL and two 145E for 20901.....
18142	5169	Feed Lifting Eccentric with 446AL, for 18319 and 18320.....
18143	5169	Feed Lifting Eccentric Connection for 18319 and 18320.....
18144	5169	Feed Lifting Eccentric Oil Pad.....
18145	22163	Feed Rock Shaft for 20904.....
18146	5169	Feed Rock Shaft Regulator Crank with 790C and two 1147AL, for 20904....
18147	5169	Feed Rock Shaft Screw Center Oil Tube (crank end) for 20904.....
18148	5169	Feed Rock Shaft Screw Center Oil Tube (feed bar end) for 20904.....
18149	5176	Loop Retainer, for single thread for 18194, 18214, 18217, 18219, 18287, 18290, 18293, 18342, 20917 and 120376.....
18152	22163	Looper Shaft for 18319.....
18153	5169	Looper Shaft Oil Cup.....
18154	5169	Looper Shaft Oil Cup Packing for 55-3, 55-4, 55-5 and 55-6 Machines
18157	5170	Needle Bar Thread Retainer Bracket for 18343, 18345 and 18350.....
18159	5170	Needle Bar Thread Retainer Spring for 18343 and 18345.....
18161	5170	Needle Clamp with 209AL, for 18308..
*18162	-----	Oscillating Rock Shaft for 18163 and 18333.....
18163	-----	Oscillating Rock Shaft complete for 55-3 to 55-5 Machines, Nos. 4784, 12388 and 18162.....
18164	5167	Presser Bar.....
18165	-----	Presser Foot Body for 18168.....
18166	-----	Presser Foot Plate, for 18168.....
18167	5180	Presser Foot Spring Stud for 18168, 18213 and 18282.....

No.	Plate	Name
18168	5180	Presser Foot (spring hinged) complete, for 55-3 Machine, Nos. 889AL, 18165 to 18167, 18200, 18201 and 18325.....
18169	5172	Slack Thread Regulator for 18136 and 18274.....
18170	5172	Slack Thread Regulator Adjusting Bracket for 18136 and 18274.....
18171	5171	Thread (under) Eyelet for 55-3 and 55-4 Machines.....
18172	5171	Thread Eyelet (top of arm) for 55-3, 55-5 and 55-6 Machines.....
18173	5171	Thread Nipper Connection complete, for 20911, Nos. 2532, 18175 and two 145E.....
18173	5171	Thread (upper) Nipper Connection complete, for 20911, Nos. 2532, 18175 and two 145E.....
18175	-----	Thread Nipper Connection Rod for 18173.....
18175	-----	Thread (upper) Nipper Connection Rod for 18173.....
18177	5171	Thread Nipper Connection Sleeve for 55-5 and 55-6 Machines.....
18177	5171	Thread (upper) Nipper Connection Sleeve for 55-3 and 55-4 Machines.....
18180	5171	Thread Nipper Plate with 13589 for 55-5 and 55-6 Machines.....
18180	5171	Thread (upper) Nipper Plate with 13589 for 55-3 and 55-4 Machines..
18181	5171	Thread Nipper Plate Stud and Thread Eyelet for 55-5 and 55-6 Machines.....
18181	5171	Thread (upper) Nipper Plate Stud and Thread Eyelet for 55-3 Machine....
18182	5171	Thread Nipper Plate Washer for 55-5 and 55-6 Machines.....
18182	5171	Thread (upper) Nipper Plate Washer for 55-3 and 55-4 Machines.....
18183	-----	Thread (under) Take-up complete for 18319 and 18320, Nos. 18184 and 18185.....
18184	5171	Thread (under) Take-up Arm for 18183
18185	5171	Thread (under) Take-up Arm Body with 453AL for 18183.....
18186	5171	Thread (under) Take-up Eyelet for 55-3 and 55-4 Machines.....
18187	5170	Thread Take-up Crank for 18323.....
18187	5170	Thread (upper) Take-up Crank for 18323 and 18324 Machines.....
18188	5170	Thread Take-up Lever for 18192.....
18188	5170	Thread (upper) Take-up Lever for 18192.....
18189	5170	Thread Take-up Lever Arm for 18192..
18189	5170	Thread (upper) Take-up Lever Arm for 18192 and 18285.....

No.	Plate	Name
18190	5170	Thread Take-up Lever Link for 18323.
18190	5170	Thread (upper) Take-up Lever Link for 18323 and 18324.....
18192	-----	Thread Take-up Lever complete, for 18323, Nos. 18188, 18189 and two 20995.....
18192	-----	Thread (upper) Take-up Lever complete for 18323, Nos. 18188, 18189 and two 20995.....
18193	5175	Throat Plate, for double thread, for 18140, 18208 and 18326, for 55-3 Machine.....
18194	5175	Throat Plate with 335D and 18149, for single thread, for 18140, 18208 and 18326, for 55-3 Machine.....
18195	-----	Presser Foot Plate for 18197.....
18196	-----	Presser Foot Shank for 18197.....
18197	22167	Presser Foot (tube) hinged, complete for 55-4 Machine, Nos. 18055, 18195 and 18196.....
18200	5180	Presser Foot Spring for heavy work, for 18168, 18213 and 18282.....
18201	5180	Presser Foot Spring for light work, for 18168, 18213 and 18282.....
18208	5175	Feed Dog, 12 teeth ( 8 teeth to the inch) for 18193 and 18194, for 55-3 Machine.....
18210	-----	Foot Lifter complete, Nos. 76D, 802D 1521J, 4880, 4885, 5598, 5670, 12237, 12240, 12415, 12416 and two 178E.....
18211	5176	Feed Dog, (17 teeth, 12 teeth to the inch) for 18214 and 18298 for 55-3 Machine.....
18212	-----	Presser Foot Plate for 18213.....
18213	5180	Presser Foot (spring hinged) complete for 18211, for 55-3 Machine, Nos. 889AL, 18167, 18200, 18201, 18212, 18215 and 18325.....
18214	5176	Throat Plate with 335D and 18149 for single thread, for 18211, for 55-3 Machine.....
18215	-----	Presser Foot Body for 18213.....
18216	5176	Feed Dog, (15 teeth, 10 teeth to the inch) for 18217 for 55-3 Machine..
18217	5176	Throat Plate with 335D and 18149, for single thread for 18216, for 55-3 Machine.....
18218	5177	Feed Dog (14 teeth, 10 teeth to the inch) for 18219 for 55-3 Machine..
18219	5177	Throat Plate with 335D and 18149, for single thread, for 18218, for 55-3 Machine.....
18231	5167	Needle Bar Crank and Thread Nipper Eccentric with 448AL and 1065AL, for 20911.....

## NUMERICAL LIST OF PARTS

No.	Plate	Name
*18272	-----	Arm with 15404 and two 15405 for 55-4 Machine.....
18273	-----	Face Plate for 18274.....
18274	5236	Face Plate complete for 55-4 Machine Nos. 66F, 1521E, 18169, 18170, 18273 and two 219F.....
18275	5203	Feed Dog, for 7/16 in. to 5/8 in. gauges, for 18286 and 18287, for 55-4 Machine.....
18276	22163	Looper Shaft, for 18320 .....
		Note: When ordering No. 18276, state gauge required.
18279	-----	Presser Foot Body for 18282.....
18280	22170	Presser Foot Hinge Pin for 18282....
18281	-----	Presser Foot Plate for 18282.....
18282	5203	Presser Foot (spring hinged) complete for 18275, for 55-4 Machine, Nos. 889AL, 18167, 18200, 18201 and 18279 to 18281.....
18283	22169	Tension (under thread) Eyelet (double) for 55-4 Machine.....
18284	5172	Thread (upper) Take-up Lever for 18285.....
18285	-----	Thread (upper) Take-up Lever complete, for 18324, Nos. 18189, 18284 and two 20995.....
18286	5203	Throat Plate for double thread, for 18275, for 55-4 Machine.....
18287	5203	Throat Plate with two each 335D and 18149, for single thread, for 18275, for 55-4 Machine.....
18288	5204	Feed Dog, for 1 1/16 in. to 1 1/8 in. gauges, for 18289 and 18290, for 55-4 Machine.....
18289	5204	Throat Plate, for double thread, for 18288, for 55-4 Machine.....
18290	5205	Throat Plate with two each 335D and 18149, for single thread, for 18288 for 55-4 Machine.....
18291	5206	Feed Dog, for 1 3/16 in. to 1 1/4 in. gauges, for 18292 and 18293 for 55-4 Machine.....
18292	5206	Throat Plate for double thread, for 18291 for 55-4 Machine.....
18293	5207	Throat Plate with two each 335D and 18149, for single thread for 18291 for 55-4 Machine.....
18294	5237	Cloth Plate for 18289 and 18290....
18295	5237	Cloth Plate for 18292 and 18293....
18298	22167	Throat Plate for double thread for 18211 for 55-3 Machine.....
18299	22166	Looper with 1120AL and 1389F for double thread for 55-3 Machine....
18299	22166	Looper (inside) with 1120AL and 1389F, for double thread for 55-4 Machine.....

## NUMERICAL LIST OF PARTS

No.	Plate	Name
18299	22166	Looper (outside) with 1120AL and 1389F for double thread for 55-4 Machine.....
18300	22166	Looper with 1120AL and 1389F for single thread for 55-3, 55-5 and 55-6 Machines.....
18300	22166	Looper (inside) with 1120AL and 1389F for single thread for 55-4 Machine.....
18300	22166	Looper (outside) with 1120AL and 1389F for single thread for 55-4 Machine.....
18301	22165	Needle Bar Connecting Link with 794E and 12384.....
18306	22168	Presser Foot for 55-6 Machine.....
18308	-----	Needle Bar 18098 with 2273 and 18161 for 55-3, 55-5 and 55-6 Machines..
18309	5240	Feed Eccentric with two 448AL for 20907.....
18312	22169	Thread (upper) Nipper Plate Stud and Thread Eyelet for 55-4 Machine....
18314	-----	Needle Bar 18098 with 2273 and 18052 for 55-4 Machine.....
18317	-----	Cloth Plate 18134 with 1044E and 18133.....
18319	-----	Looper Shaft 18152 with 18142, 18143 18183 and 19447, for 55-3, 55-5 and 55-6 Machines.....
18320	-----	Looper Shaft 18276 with 18142, 18143 18183 and 19447 for 55-4 Machine..
18323	-----	Thread Take-up Lever 18192 with 775E 11204, 18187 and 18190 for 55-5 and 55-6 Machines.....
18323	-----	Thread (upper) Take-up Lever 18192 with 775E, 11204, 18187 and 18190, for 55-3 Machine.....
18324	-----	Thread (upper) Take-up Lever 18285 with 775E, 11204, 18187 and 18190, for 55-4 Machine.....
18325	22170	Presser Foot Hinge Pin for 18168 and 18213.....
18326	5175	Feed Dog, 23 teeth (16 teeth to the inch) for 18193 and 18194, for 55-3 Machine.....
*18327	-----	Arm with 15404 and two 15405 for 55-6 Machine.....
18328	22163	Arm Shaft for 20908.....
18329	5240	Arm Shaft Flanged Bushing (back) for 55-6 Machine.....
18331	22164	Belt Cover Bracket with 871E and 43585, for 55-6 Machine.....
18332	22168	Feed Dog for 18342 for 55-6 Machine.
18333	-----	Oscillating Rock Shaft complete for 55-6 Machine, Nos. 4784, 18162 and 18334.....

## NUMERICAL LIST OF PARTS

No.	Plate	Name
18334	5240	Oscillating Rock Shaft Hinge Pin for 18333.....
18335	5240	Pulley (tight) with 624AL for 18336.
18336	-----	Pulley (tight) complete for 18337, Nos. 871E, 14263, 18335, 21615 to 21617, 21653 and two 997E.....
18337	-----	Pulleys complete for 55-6 Machine, Nos. 18336 and 66085.....
18338	22163	Starting Lever for 18339.....
18339	-----	Starting Lever complete, for 55-6 Machine, Nos. 159F, 803C, 913C, 1520E, 1638E, 14260, 14277, 18338, 18341, 21845, 21651, 43583 and two 399F.....
18340	22163	Starting Lever Bracket for 55-6 Machine.....
18341	22171	Stop Cam Interlocking Rod Guide with 1070C for 18339.....
18342	22168	Throat Plate with 335D and 18149, for single thread for 18332 for 55-6 Machine.....
18343	-----	Needle Bar Thread Retainer Bracket complete for 55-3 Machine, Nos. 453AL, 462AL, 12400, 18157, 18159, 18344 and 20910.....
18344	22165	Needle Bar Thread Retaining Stud for 18343 and 18350.....
18345	-----	Needle Bar Thread Retainer Bracket complete for 55-4 Machine Nos. 453AL, 462AL, 12400, 18157, 18159, 18346, 20910 and 21020.....
18346	22170	Needle Bar Thread Retaining Stud for 18345.....
18347	-----	Starting Lever Chain 38 in. long with two 56865 for 55-6 Machine.....
18348	22169	Starting Lever Chain Connection for 55-6 Machine.....
18349	22169	Needle Bar Thread Retainer Spring for 18350.....
18350	-----	Needle Bar Thread Retainer Bracket complete for 55-5 and 55-6 Machines, Nos. 453AL, 462AL, 12400, 18157, 18344, 18349 and 20910.....
18498	22163	Belt Cover for 55-6 Machine.....
19219	22174	Bed Frame Cushion (leather) for 20067 (4).....
19220	22174	Bed Frame Cushion Spring for 20067 (4).....
19221	22173	Wrench for 936 and 1819 (Accessories)
19226	22174	Bed Frame Hinge Connection for 19398 (2).....
19397	22174	Bed Frame Hinge Connection Cap for 19398 (2).....
19398	-----	Bed Frame Hinge Connection 19226 with 211F and 19397 for 20067 (2).

## NUMERICAL LIST OF PARTS

No.	Plate	Name
19447	22165	Looper Shaft Crank complete for 18319 and 18320, Nos. 457AL, 1518J 19449 and 19496.....
19448	22165	Looper Shaft Crank Slide Block for 19449.....
19449	-----	Looper Shaft Crank Slide Block complete for 19447, Nos. 226J, 988C, 12424 and 19448.....
19496	-----	Looper Shaft Crank for 19447.....
20023	22164	Presser Bar Spring (heavy) for 55-3, 55-4 and 55-6 Machines.....
20067	819	Bed Frame with two each 16555, 19398 four each 19219, 19220, six each 14010 wood screws 1 1/4 in. No. 12 and eight 158C.....
20197	22164	Crank Connecting Rod with two 896AL.
20901	-----	Feed Eccentric Connecting Rod 18141 with 389F, 697C and 11137, for 55-3, 55-4 and 55-6 Machines.....
20904	-----	Feed Rock Shaft 18145 with 18146 to 18148.....
20905	-----	Arm Shaft 18131 with 5570 and 20911 for 55-3 and 55-4 Machines.....
20907	-----	Arm Shaft 18131 with 18309 and 20911 for 55-5 Machine.....
20908	-----	Arm Shaft 18328 with 5570 and 20911 for 55-6 Machine.....
20910	22165	Needle Bar Thread Retaining Collar for 18343, 18345 and 18350.....
20911	-----	Needle Bar Crank and Thread Nipper Eccentric 18231 with 18173 for 20905, 20907 and 20908.....
*20912	-----	Bed for 55-3 to 55-5 Machines.....
20913	5240	Feed Bar with 176J.....
20914	-----	Tension Screw Stud 1046C with 1560C for 55-5 and 55-6 Machines.....
20914	-----	Tension (upper thread) Screw Stud 1046C with 1560C, for 55-3 and 55-4 Machines.....
*20915	-----	Bed for 55-6 Machine.....
20916	22167	Feed Dog for 20917 for 55-5 Machine.
20917	22172	Throat Plate with 335D and 18149 for single thread for 20916 for 55-5 Machine.....
20921	-----	Presser Foot Plate (left) for 20925.
20922	-----	Presser Foot Plate (right) for 20925
20923	-----	Presser Foot Shank with 7311 for 20925 (2).....
20924	-----	Presser Foot Shank Bracket for 20925
20925	22167	Presser Foot (hinged compensating) complete for 55-5 Machine, Nos. 106D, 220D, 7309, 7310, 20921, 20922, 20924, and two each 20923 and 62527.....

## NUMERICAL LIST OF PARTS

No.	Plate	Name
20926	22169	Presser Bar Spring Bracket with 453AL for 55-3 Machine.....
20927	22163	Feed Eccentric Connecting Rod with 896AL and two 145E for 20928.....
20928	-----	Feed Eccentric Connecting Rod 20927 with 389F, 697C and 11137 for 55-5 Machine.....
20989	-----	Knee Lifter complete (power table) Nos. 76D, 802D, 1521J, 5598, 12237, 12240, 12415, 12416, 139624 and two 178E.....
20990	-----	Knee Lifter complete (individual motors and foot power stands) Nos. 76D, 802D, 1521J, 5598, 12237, 12240, 12415, 12416, 139625 and two 178E.....
20995	22170	Thread Take-up Lever Rivet for 18192 (2).....
20995	22170	Thread (upper) Take-up Lever Rivet for 18192 and 18285 (2).....
21020	5172	Needle Bar Thread Retaining Thread Separator for 18345.....
21615	5240	Stop Cam Spring (long) for 18336....
21616	5240	Stop Cam Spring (short) for 18336....
21617	22171	Stop Cam Spring Stop Block for 18336
21645	22169	Starting Lever Cushion (rawhide) for 18339.....
21651	5240	Stop Cam Interlocking Rod Spring for 18339.....
21652	22171	Stop Cam Pin for 14263.....
21653	5240	Stop Cam Spring Cover for 18336.....
23668	22169	Pulley (tight) Pin for 55-6 Machine.
23868	22169	Thread Eyelet (top of arm) for 55-4 Machine.....
24297	22164	Balance Wheel Oil Cover for use with 2135 and 2862 for 55-3 and 55-4 Machines.....
26026	22173	Screw Driver (machine) (Accessories)
26061	989	Tape Holder Bracket Wire with Disc for 26063.....
26062	989	Tape Holder Disc (adjustable) with 51224J and 35925, for 26063.....
26063	989	Tape Holder complete for 26065, Nos. 26061 and 26062.....
26064	22172	Tape Holder Foot with 736D and three wood screws 1 in. No. 12 for 26343
26065	-----	Tape Holder (8 in. disc) with Foot complete, Nos. 26063 and 26325....
26066	989	Tape Holder Bracket Wire for 26067..
26067	-----	Tape Holder Bracket Wire complete for 26074, Nos. 26066, 26068 and 26072.....
26068	989	Tape Holder Disc for 26067 and 26071
26069	989	Tape Holder Disc Hub for 26071.....
26071	-----	Tape Holder Disc complete for 26074 Nos. 26068 and 26069.....

## NUMERICAL LIST OF PARTS

No.	Plate	Name
26072	989	Tape Holder Tape Guide for 26067....
26073	22174	Tape Holder Tension Adjusting Collar with 51224W for 26074.....
26074	989	Tape Holder complete for 26343, Nos. 13211, 26067, 26071 and 26073.....
26325	22172	Tape Holder Foot with 736D and three wood screws 1 in. No. 12 for 26065
26343	-----	Tape Holder (10 in. disc) with Foot complete, Nos. 26064 and 26074....
26463	956	Guide (1 1/2 in. face) for 55-3 and 55-4 Machines.....
26485	22173	Screw Driver (shuttle tension) (Accessories).....
26693	956	Guide (4 in. face) for 55-3 and 55-4 Machines.....
27739	7234	Thread Unwinder Thread Cone (wood) for large cones, for 225258, 225260, 259143 and 259144.....
Note: No. 27739 is used with, but not included in Numbers 225258, 225260, 259143 and 259144.		
28971	22171	Guide for 120428.....
28972	22171	Guide Holder for 120373, 120428 and 120439.....
28973	22171	Guide Holder Shank for 120373 and 120439.....
35610	22171	Guide Holder Friction Washer for 120373, 120428 and 120439.....
35627	22172	Edge Folder for 35629.....
35628	22172	Edge Folder Hinge Plate for 35629...
35629	22172	Edge Folder (double) swinging complete for burlap bags, for 55-3 Machine, Nos. 74D, 35627 and 35628
35630	22172	Edge Folder (double) on Shank, for closing burlap bags, for 55-3 Machine.....
35713	5238	Edge Folder on Shank for 55-4 Machine.....
35714	5238	Lap Seam Guide on Shank, for canvas work, for 55-4 Machine.....
35925	-----	Tape Holder Disc Hub for 26062.....
36818	5809	Finger Guard for 36821.....
36819	5809	Finger Guard Friction Washer for 36821.....
36820	5809	Finger Guard Holder with 196J for 36821.....
36821	5809	Finger Guard complete for 55-3, 55-5 and 55-6 Machines, Nos. 36818 to 36820 and 50316J.....
41400	22173	Machine Rest Pin (wood) (Accessories)
43583	5240	Stop Cam Interlocking Rod for 18339.
43585	22169	Belt Cover Bracket Stud for 18331...
50302J	22175	Finger Guard Holder Set, Screw for 120497.....
50316J	5809	Finger Guard Hinge Screw for 36821..

No.	Plate	Name
51224W	22162	Arm Side Cover Thumb Screw.....
51224W	22162	Face Plate Thumb Screw.....
51224W	22162	Guide Thumb Screw for 120373, 120428 and 120439.....
51224J	22162	Tape Holder Disc Thumb Screw for 26062.....
51224W	22162	Tape Holder Tension Adjusting Collar Thumb Screw for 26073.....
52016	22170	Presser Bar Lifter for 55-3, 55-4 and 55-6 Machines.....
52045	22162	Arm Oil Tube Packing (cotton) for 11119.....
56813	-----	Feed Bar Screw Center 313C with 1519J (2).....
56814	-----	Feed Rock Shaft Screw Center 307C with 1513J (2).....
*56827	-----	Clamp Stop Motion Flanged Bushing 3023 with 256J for 55-4 Machine...
56848	-----	Bell Crank 5596 with 5599 and 5601, for 5598.....
56864	22175	Foot Lifter Chain Hook (large) for 5670.....
56865	22169	Foot Lifter Chain Hook (small) for 5670.....
56865	22169	Starting Lever Chain Hook for 18347 (2).....
56899	-----	Balance Wheel (light rim) "V" belt groove (outside diam. of belt groove 2.9 in.) with two 435AL for 55-3 to 55-5 Machines.....
58590	-----	Tension (under thread) Screw Stud 686E with 1560C, for 55-3 and 55-4 Machines.....
62527	22169	Presser Foot Hinge Pin for 20925 (2)
66085	22163	Pulley (loose) for 18337.....
120341	22173	Tweezers (curved) (Accessories).....
120344	22173	Oiler (copper plated) with 120345 (Accessories).....
120345	22173	Oiler Spout, 4 1/2 in. long for 120344.....
120371	22167	Feed Dog for basting, for 120376 for 55-5 Machine.....
120372	22171	Guide for basting for 120373.....
120373	22171	Guide (adjustable hinged) complete, for basting for 55-5 Machine, Nos. 940W, 7071, 28972, 28973, 35610, 51224W and 120372.....
120376	22168	Throat Plate with 335D and 18149 for single thread for 120371, for 55-5 Machine.....
120427	22171	Guide Holder Shank for 120428.....
120428	22171	Guide (adjustable hinged) complete for 55-5 Machine, Nos. 940W, 7071, 28971, 28972, 35610, 51224W and 120427.....

No.	Plate	Name
120438	22172	Guide for 120439.....
120439	22172	Guide (adjustable, hinged) complete, for 55-5 Machine, Nos. 940W, 7071, 28972, 28973, 35610, 51224W and 120438.....
120496	22175	Finger Guard for 120498.....
120497	22175	Finger Guard Holder with 50302J for 120498.....
120498	-----	Finger Guard complete, Nos. 236J, 120496 and 120497, for 55-3, 55-5 and 55-6 Machines.....
127312	22177	Rock Shaft Hanger (back) with two wood screws 1 in. No. 10 F.H. for 139624.....
132590	22162	Arm Oil Tube Packing (wick) for 12454.....
139623	22177	Rock Shaft Lifting Bracket Hook for 139633.....
139624	22177	Rock Shaft complete for 20989, Nos. 2768, 12242, 127312 and 139633....
139625	22177	Rock Shaft complete, for 20990, Nos. 2768, 139633 and two 7539.....
139633	-----	Rock Shaft 2763 with 2770, 6337 and 139623 for 139624 and 139625.....
139637	22176	Drip Pan with four 1 in. wire nails.
140219C	22175	Rock Shaft Stop Dog Set Screw for 2770.....
150203	22178	Thread Unwinder Spool Rest Cushion (felt) for 225258; 225260, 259143 and 259144.....
200383C	22174	Thread Unwinder Spool Rest Rod Set Screw for 259658.....
201018C	22174	Thread Unwinder Spool Rest Set Screw for 225257 and 225259.....
201696J	22174	Thread Unwinder Thread Guide Lock Nut for 225258, 225260, 259143 and 259144.....
225257	22178	Thread Unwinder Spool Rest with 201018C for 225258, 259143 and 259144.....
225258	22180	Thread Unwinder complete (for two spools or two large cones of thread) for 55-5 Machine, Nos. 201696J, 225257, 225324, 225326, 225388, 259658, two each 150203, 225391 and three wood screws 7/8 in. No. 12 F.H.....
225259	22178	Thread Unwinder Spool Rest (for one spool) with 201018C for 225260 and 259143.....
225260	22181	Thread Unwinder complete (for one spool or one large cone of thread) for 55-6 Machine, Nos. 150203, 201696J, 225259, 225324, 225326, 225388, 225391, 259658 and three wood screws 7/8 in. No. 12 F.H....

## NUMERICAL LIST OF PARTS

No.	Plate	Name
225322	22174	Thread Unwinder Thread Guide Rod Washer for 225324.....
225324	22178	Thread Unwinder Thread Guide Rod with 208AL and 225322 for 225258, 225260, 259143 and 259144.....
225326	22174	Thread Unwinder Thread Guide Position Cup for 225258, 225260, 259143, and 259144.....
225388	22178	Thread Unwinder Spool Rest Rod for 225258, 225260, 259143 and 259144.
225390	7234	Thread Unwinder Thread Cone Holder for inverted cones for 225258, 225260, 259143 and 259144.....
Note: No. 225390 is used with, but not in- cluded in 225258, 225260, 259143 and 259144.		
225391	22178	Thread Unwinder Thread Guide for 225258, 225260, 259143 and 259144.
259143	22178	Thread Unwinder complete (for three spools or three large cones of thread) for 55-3 Machine, Nos. 201696J, 225257, 225259, 225324, 225326, 225388, 259658, three each 150203, 225391 and wood screws 7/8 in. No. 12.....
259144	22179	Thread Unwinder complete (for four spools or four large cones of thread) for 55-4 Machine, Nos. 201696J, 225324, 225326, 225388, 259658, two 225257, three wood screws 7/8 in. No. 12, four each 150203 and 225391.....
259658	22178	Thread Unwinder Spool Stand with 200383C for 225258, 225260, 259143 and 259144.....

ILLUSTRATIONS  
OF  
PARTS



PLATE 819—ONE-FOURTH SIZE

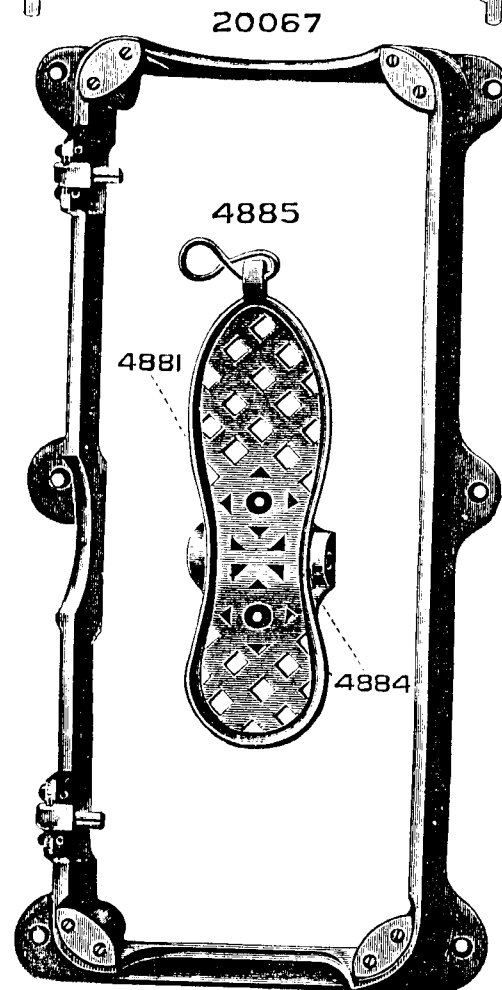
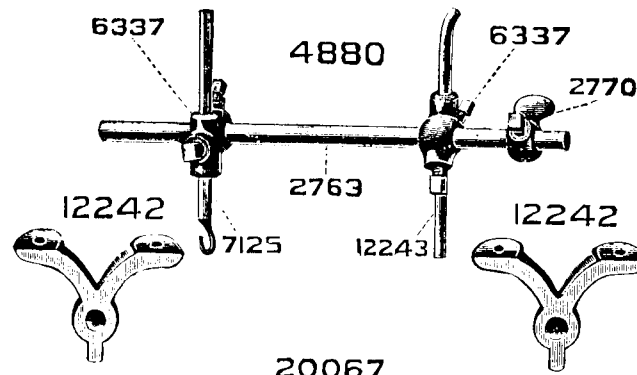
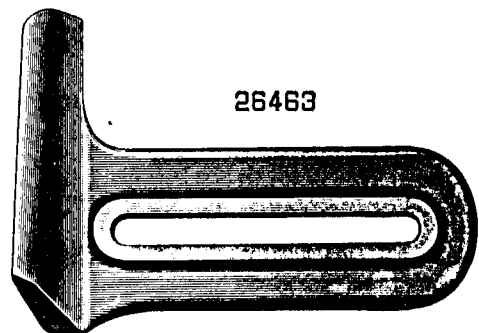
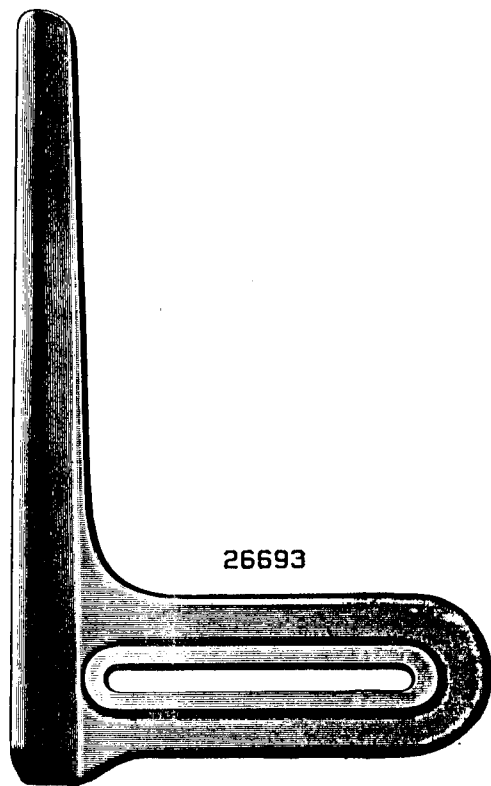


PLATE 956—FULL SIZE



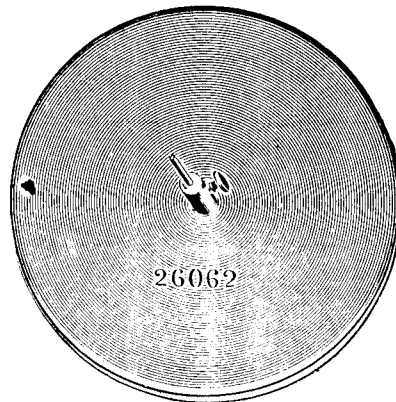
26463



26693

PLATE 989—ONE-FOURTH SIZE

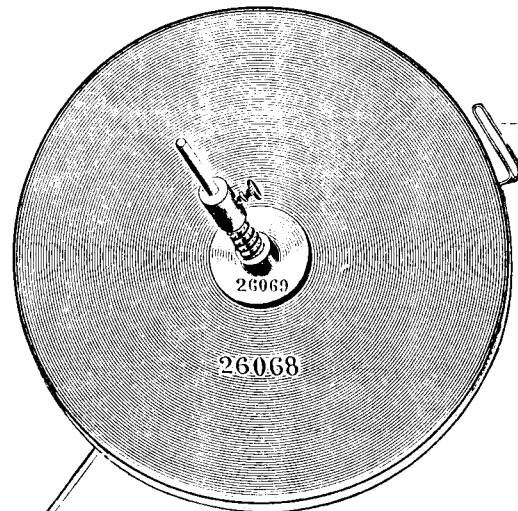
26063



26062

26061

26074



26072

26068

26066

PLATE 5150—ONE-FOURTH SIZE

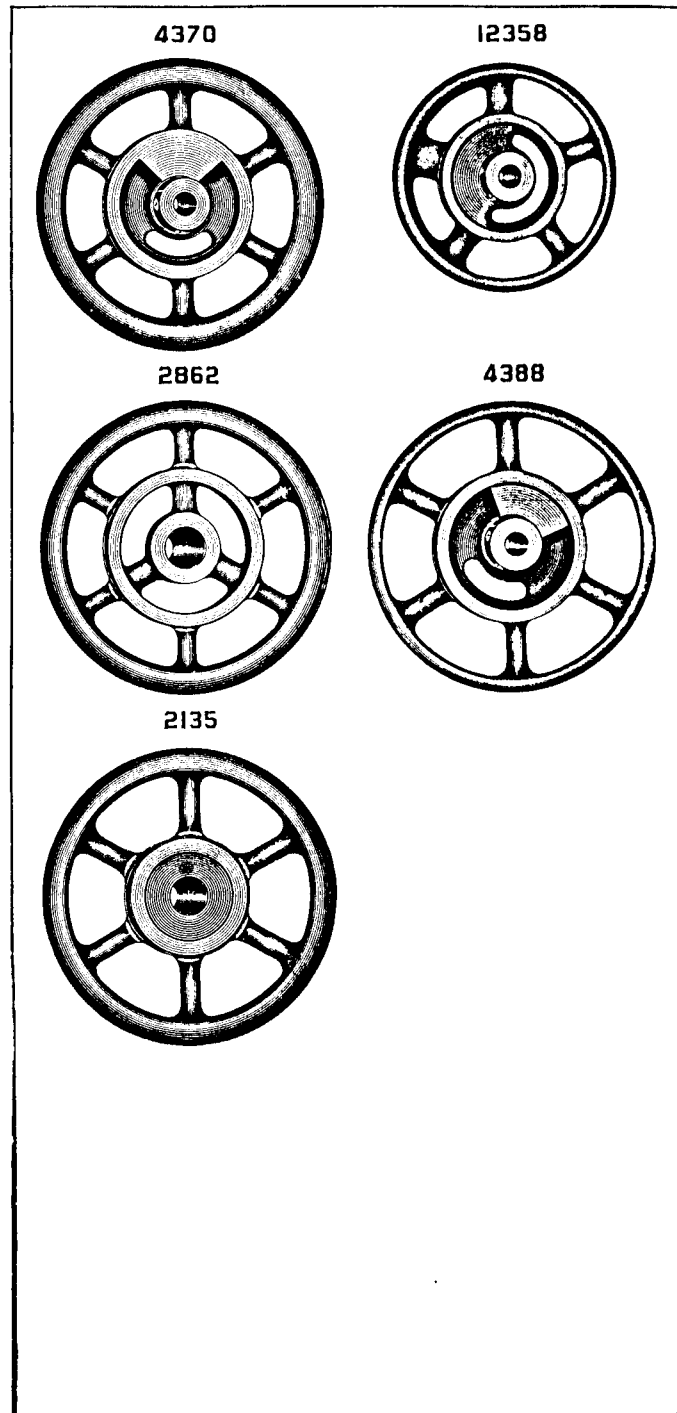


PLATE 5163—FULL SIZE

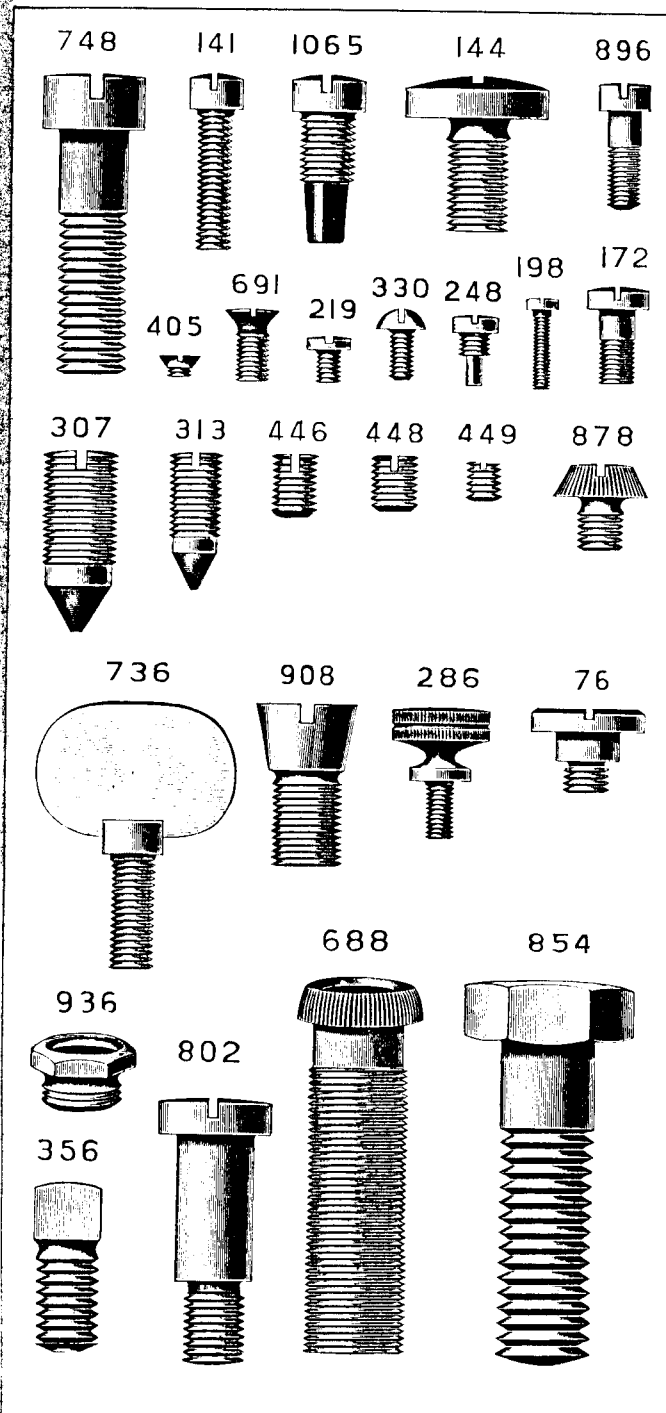


PLATE 5164—FULL SIZE

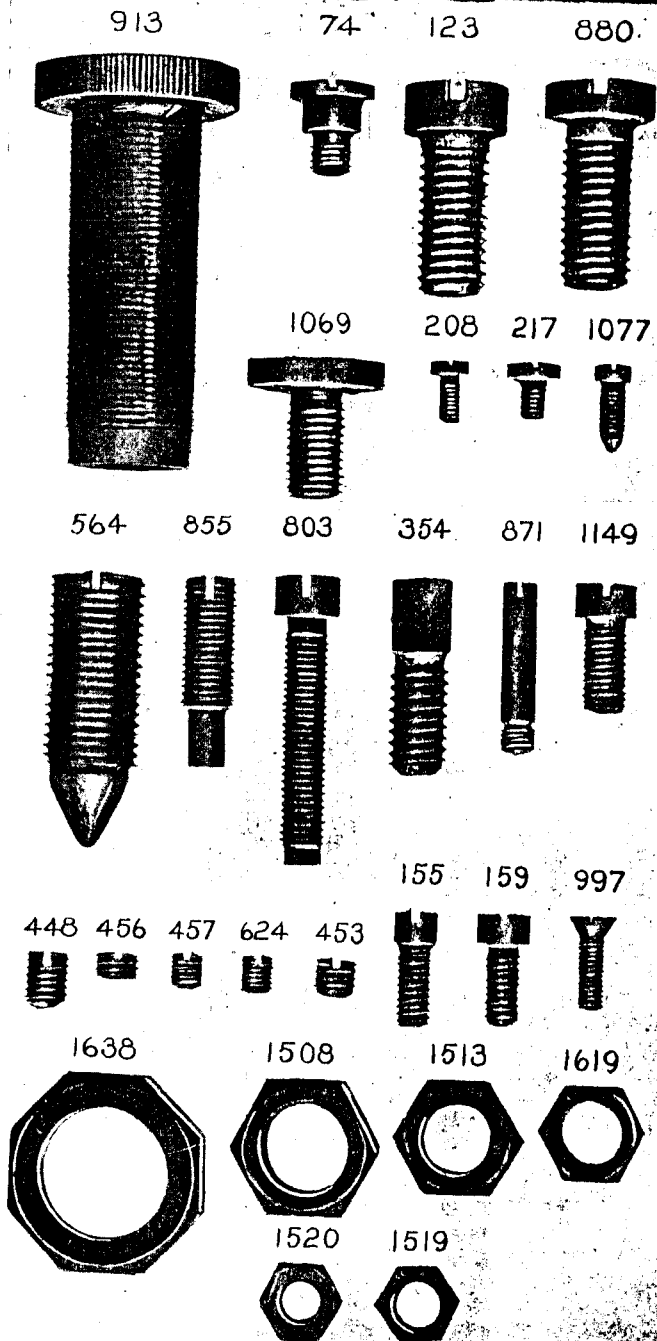
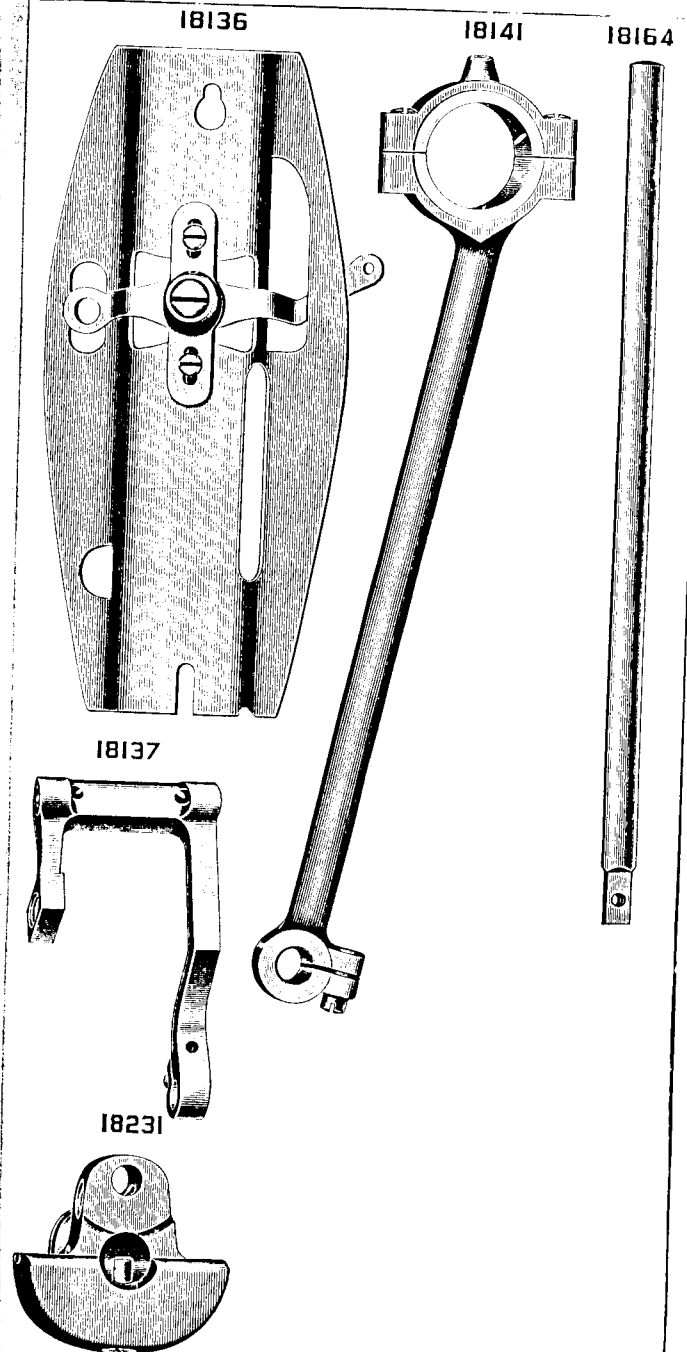


PLATE 5167—ONE-HALF SIZE



From the library of: Diamond Needle Corp

PLATE 5168—ONE-HALF SIZE

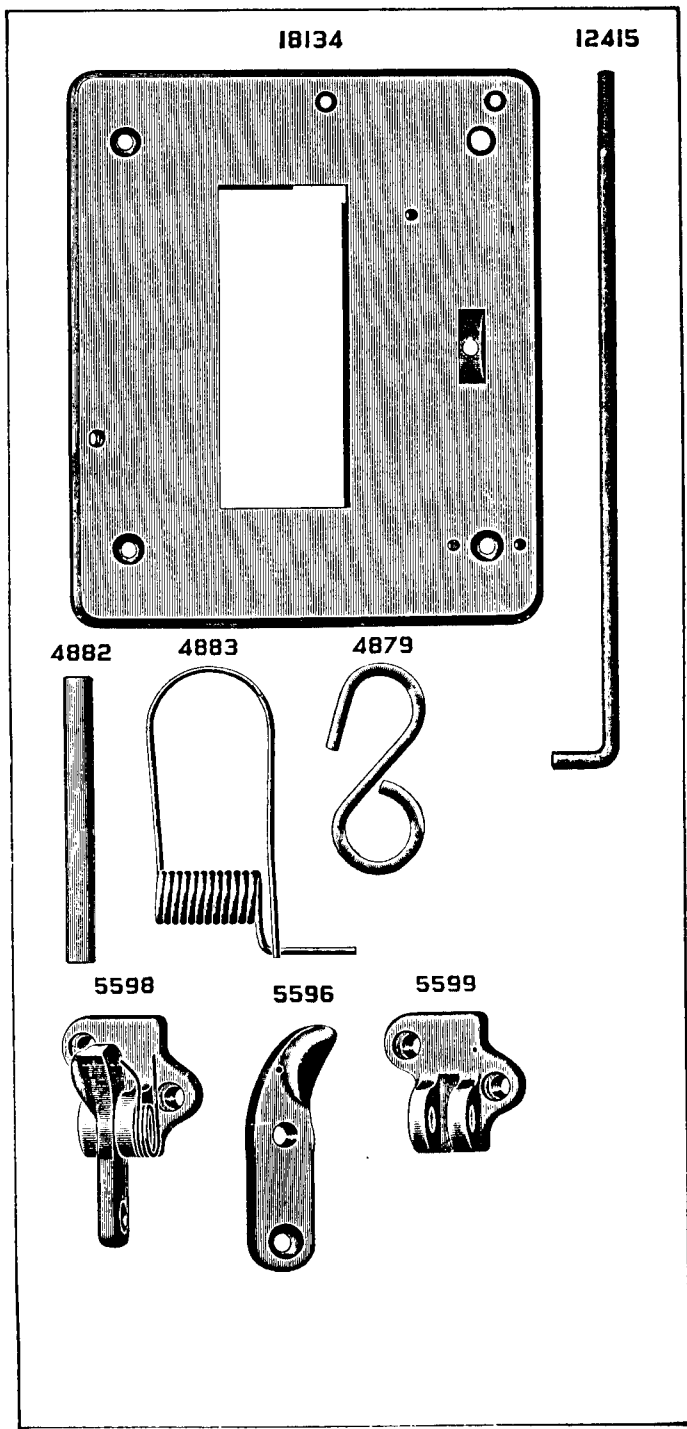
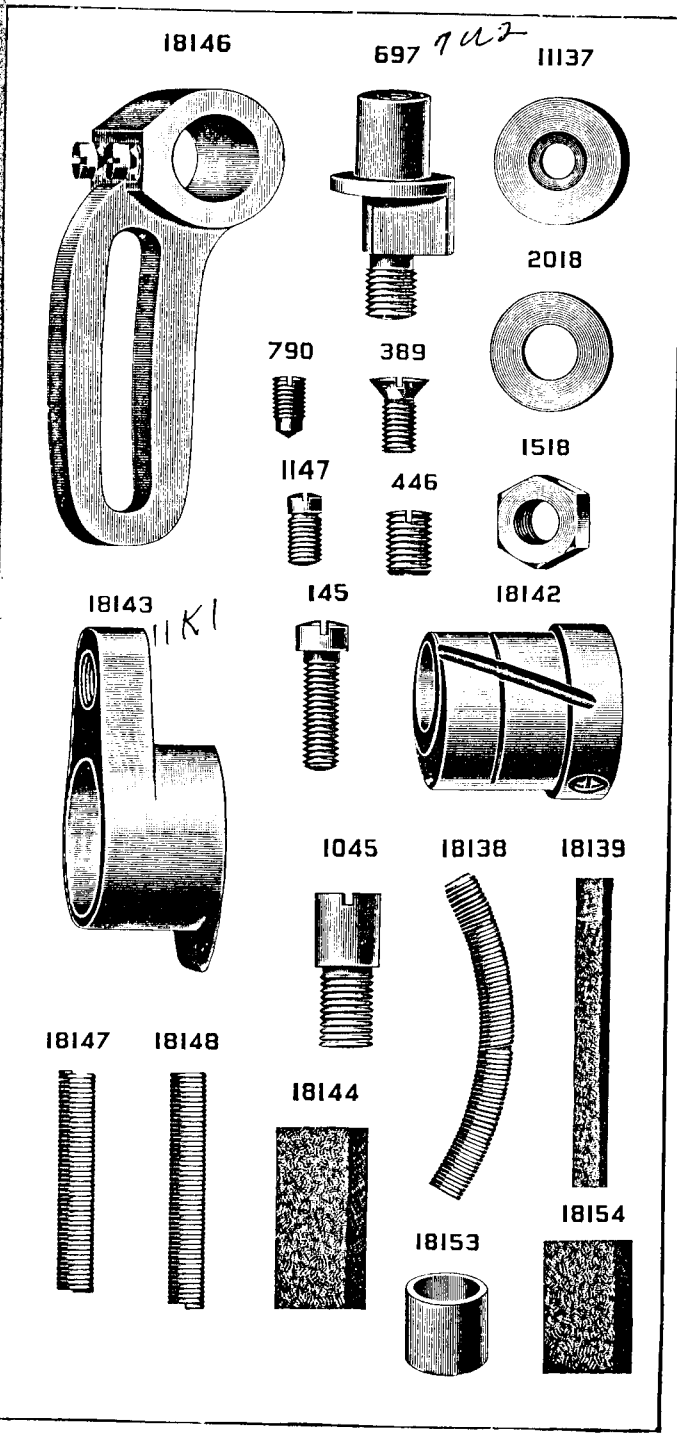


PLATE 5169—FULL SIZE



From the library of: Diamond Needle Corp

PLATE 5170—FULL SIZE

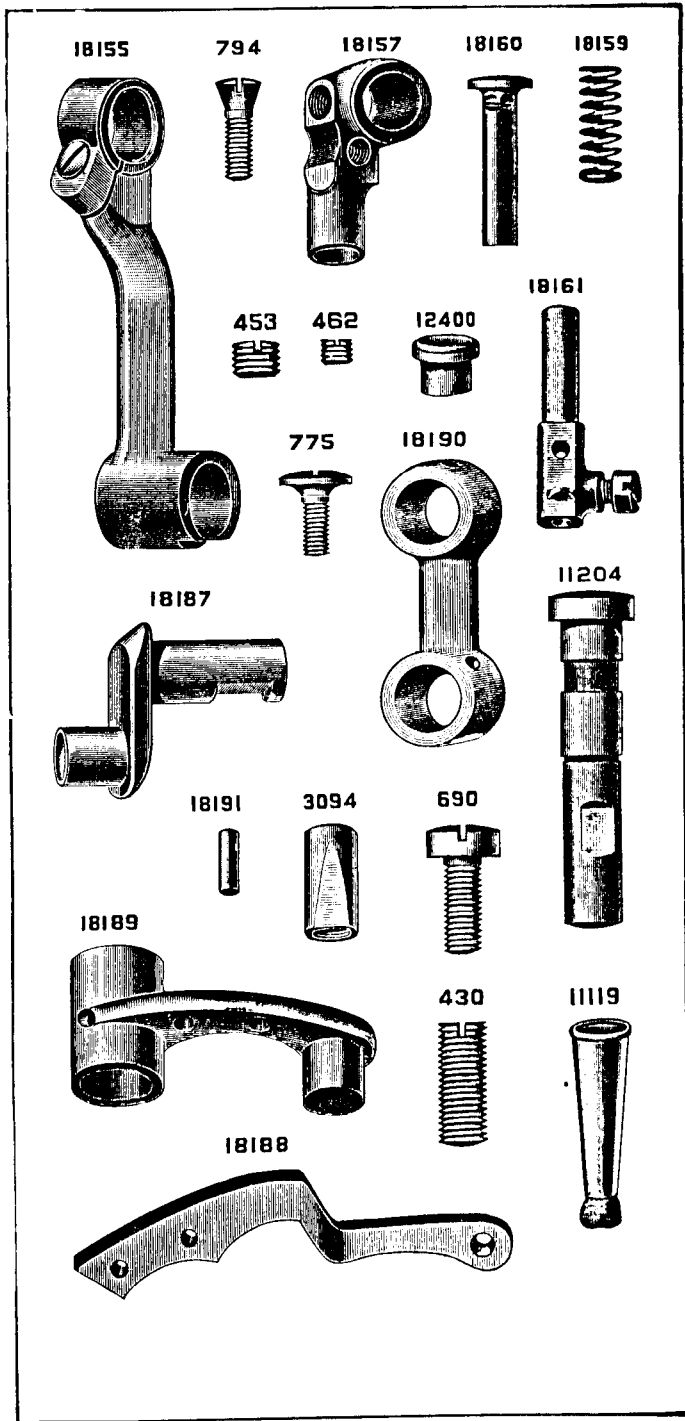
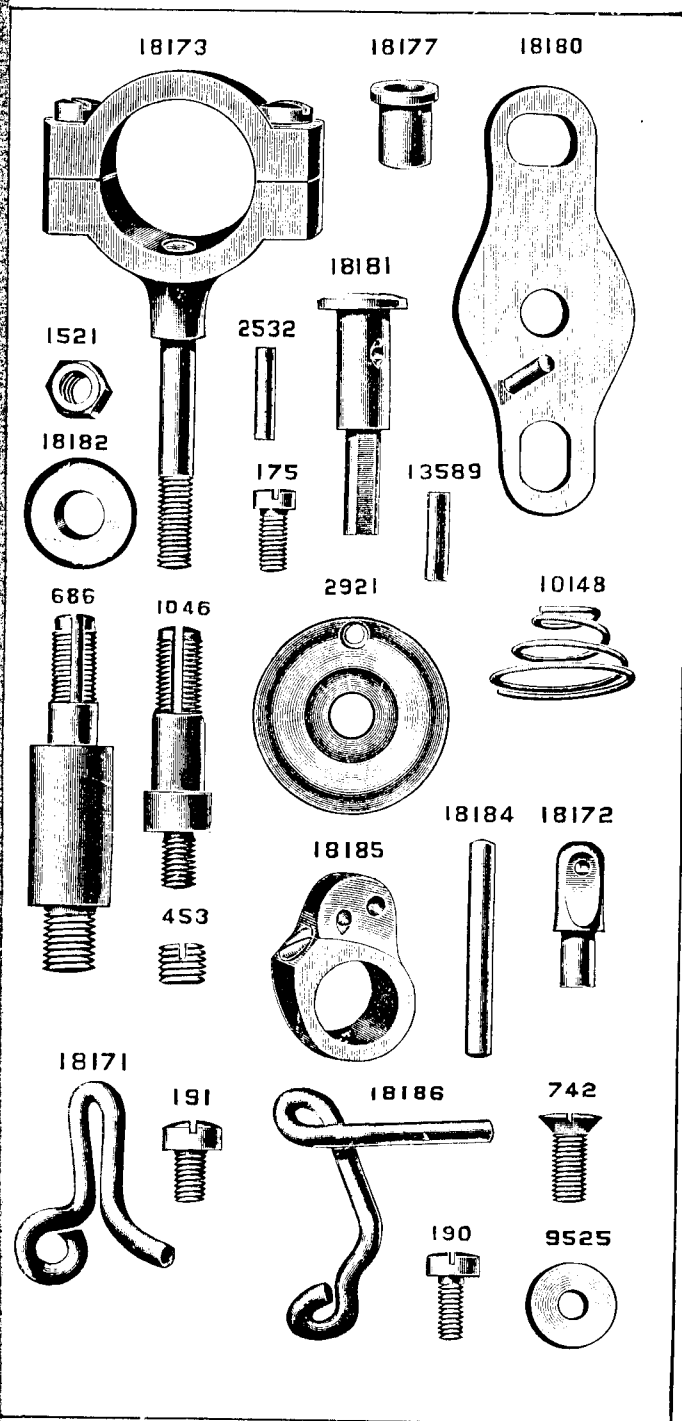


PLATE 5171—FULL SIZE



From the library of: Diamond Needle Corp

PLATE 5172—FULL SIZE

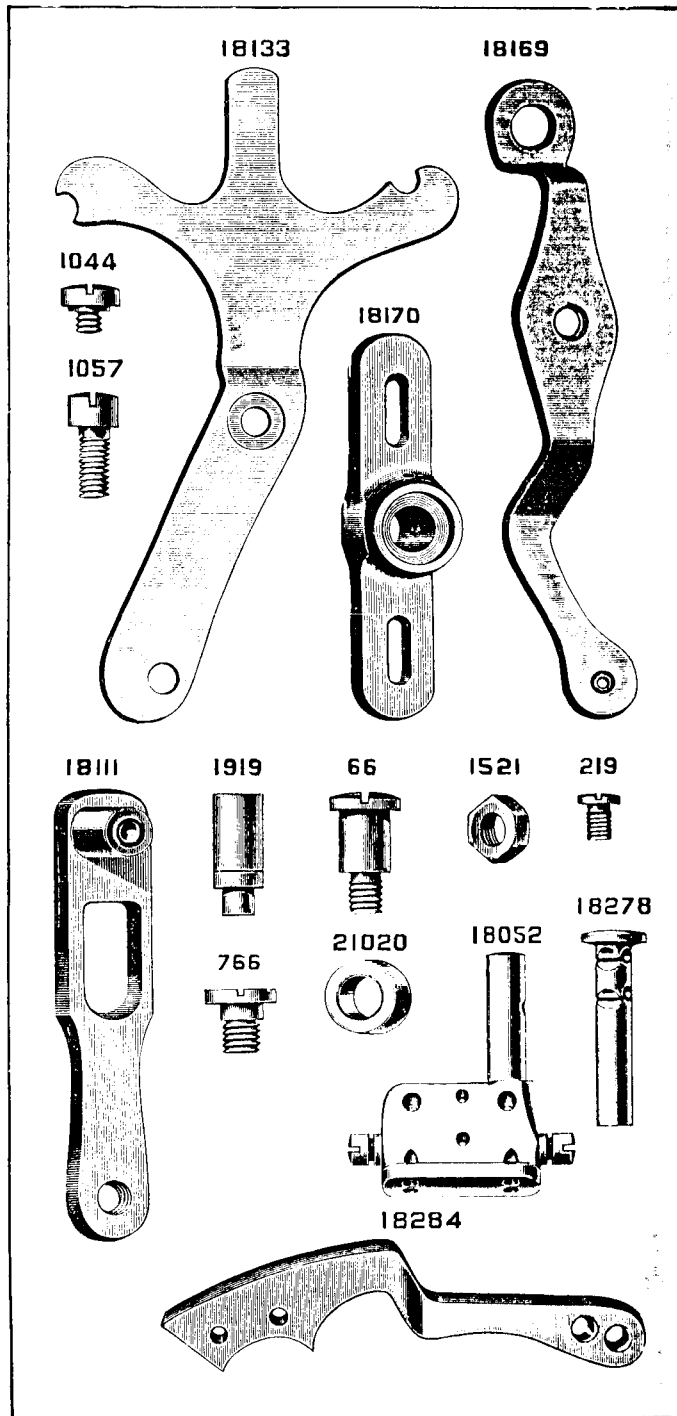


PLATE 5175—FULL SIZE

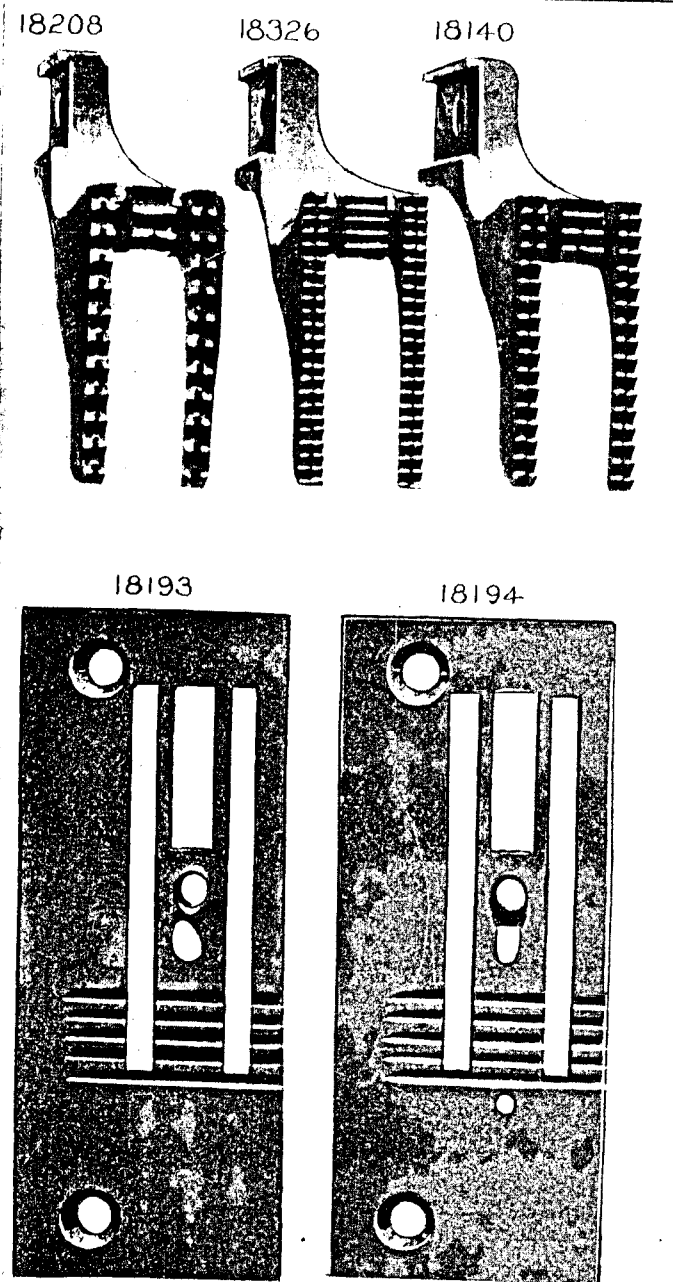


PLATE 5176—FULL SIZE

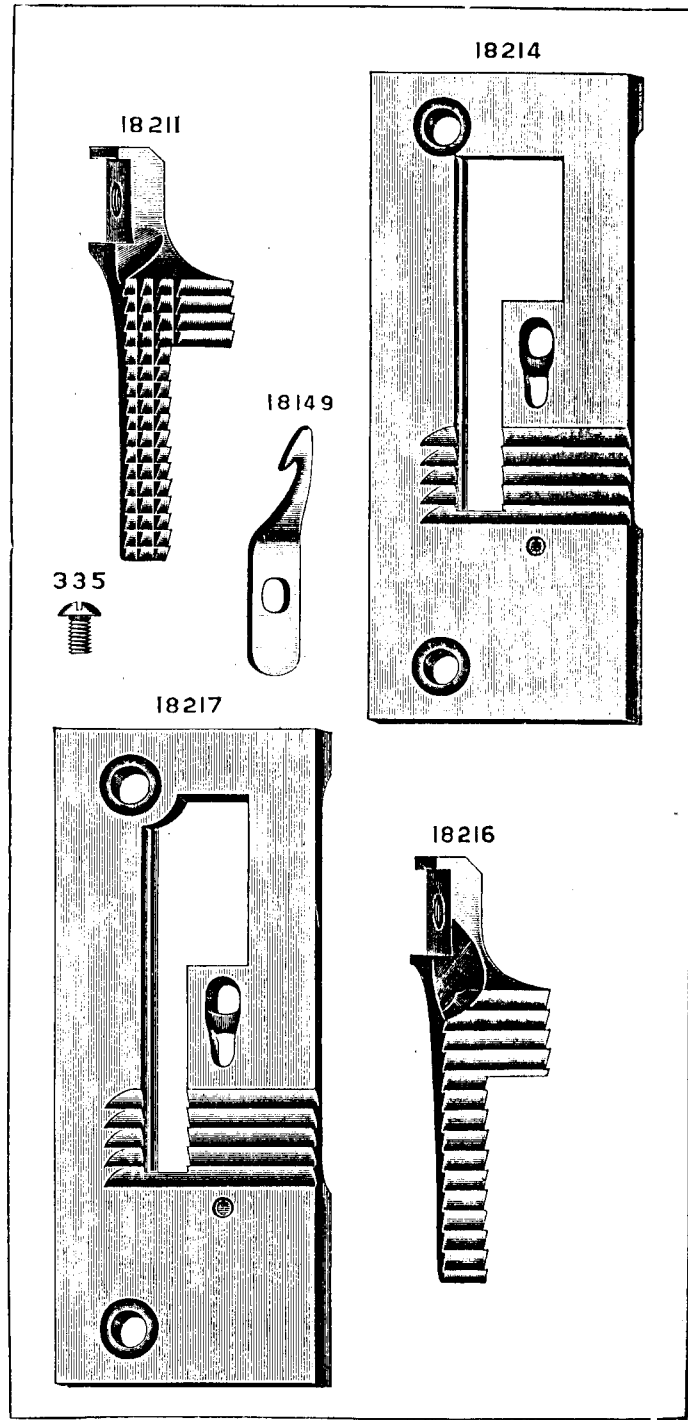


PLATE 5177—FULL SIZE

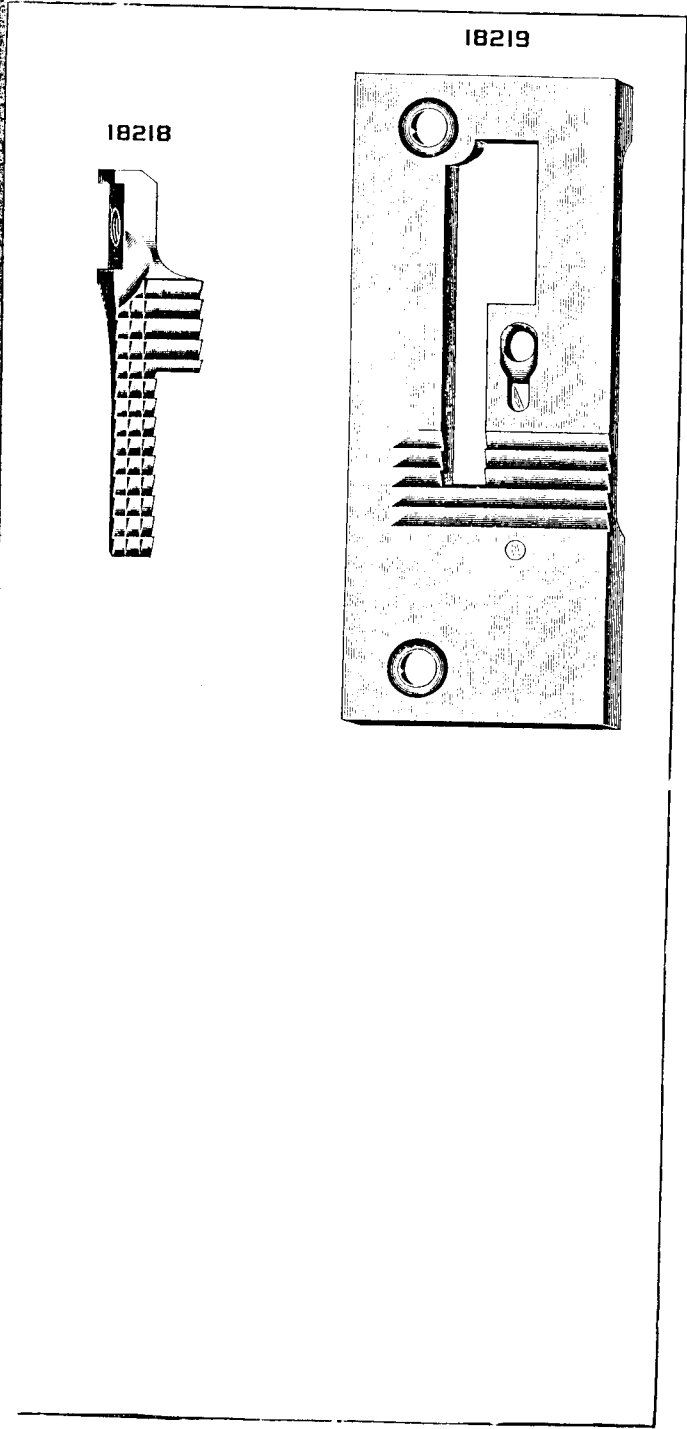
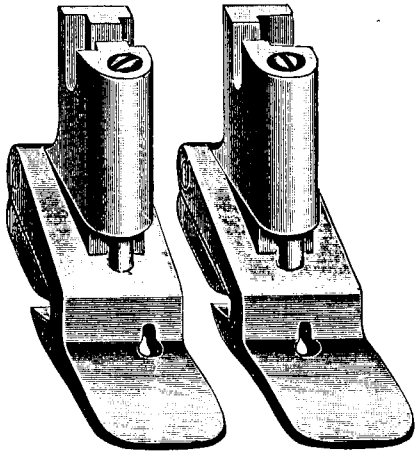




PLATE 5180—FULL SIZE

18213

18168



18200

18201

8285

889

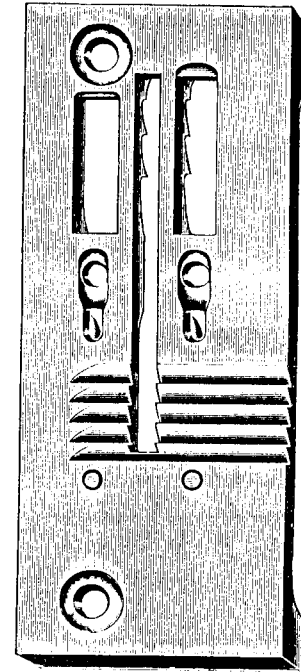
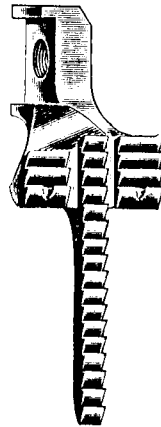
18167



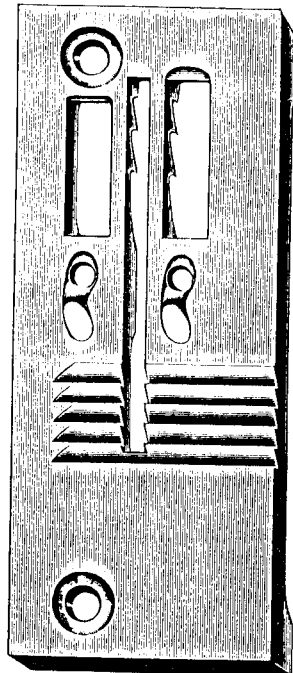
PLATE 5203—FULL SIZE

18287

18275



18286



18282

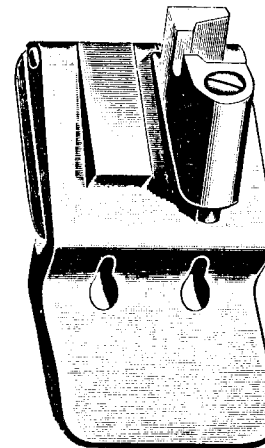
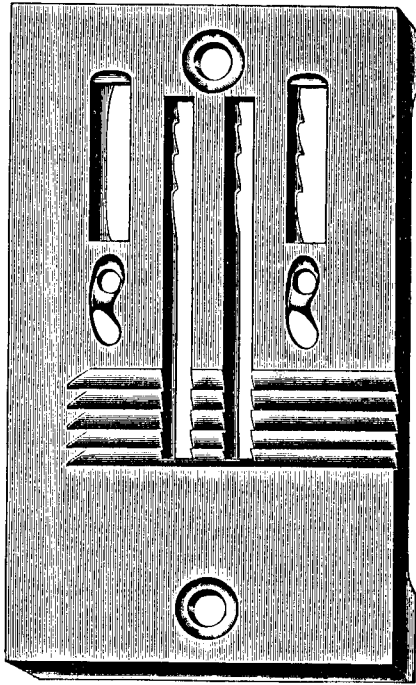


PLATE 5204—FULL SIZE

18289



18288

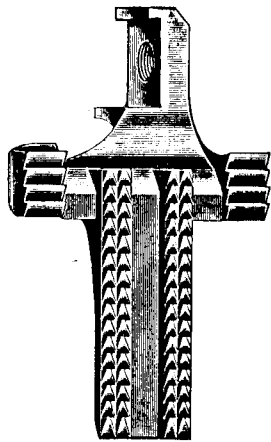


PLATE 5205—FULL SIZE

18290

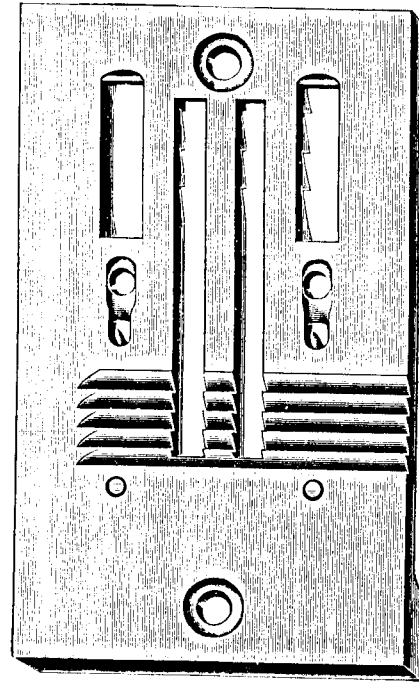
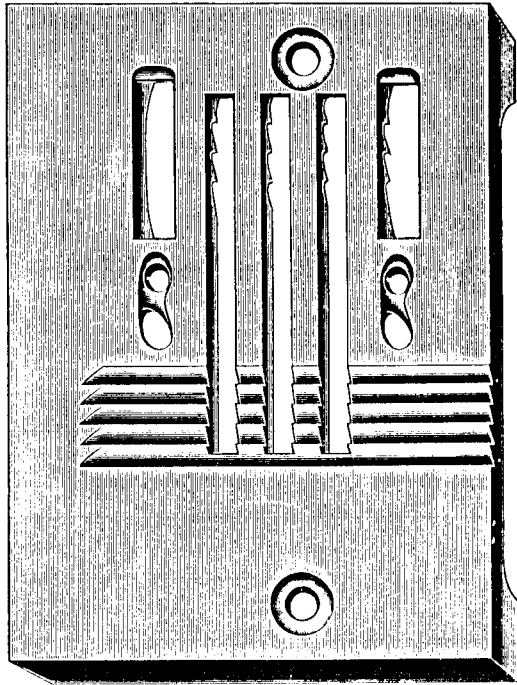


PLATE 5206—FULL SIZE

18292



18291

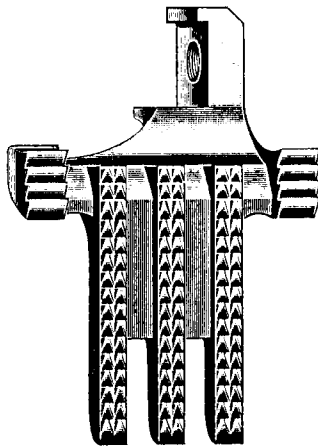


PLATE 5207—FULL SIZE

18293

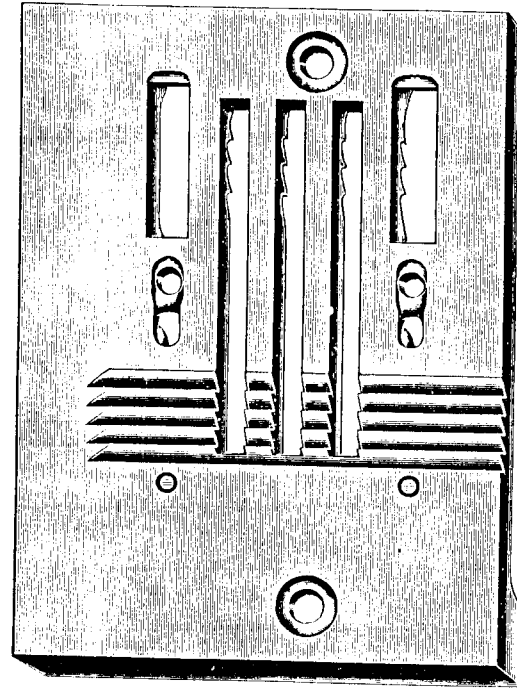


PLATE 5236—ONE-HALF SIZE

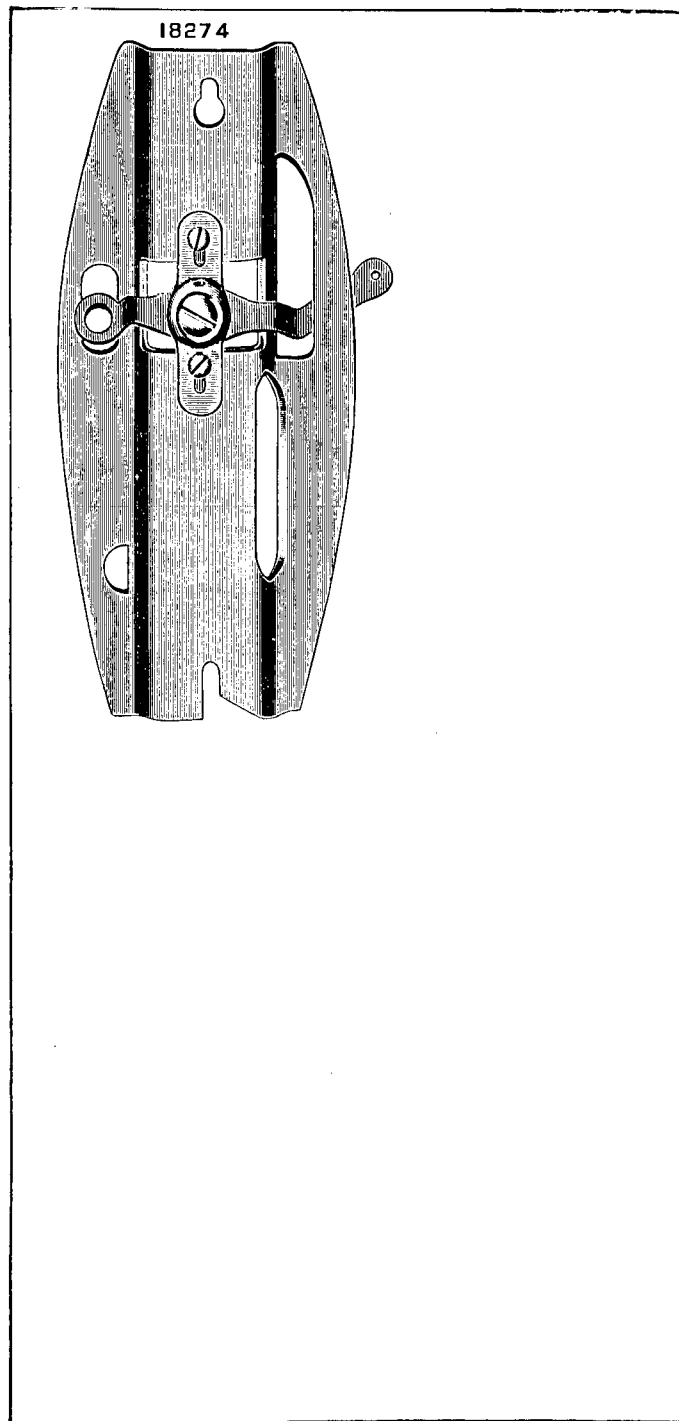


PLATE 5237—ONE-HALF SIZE

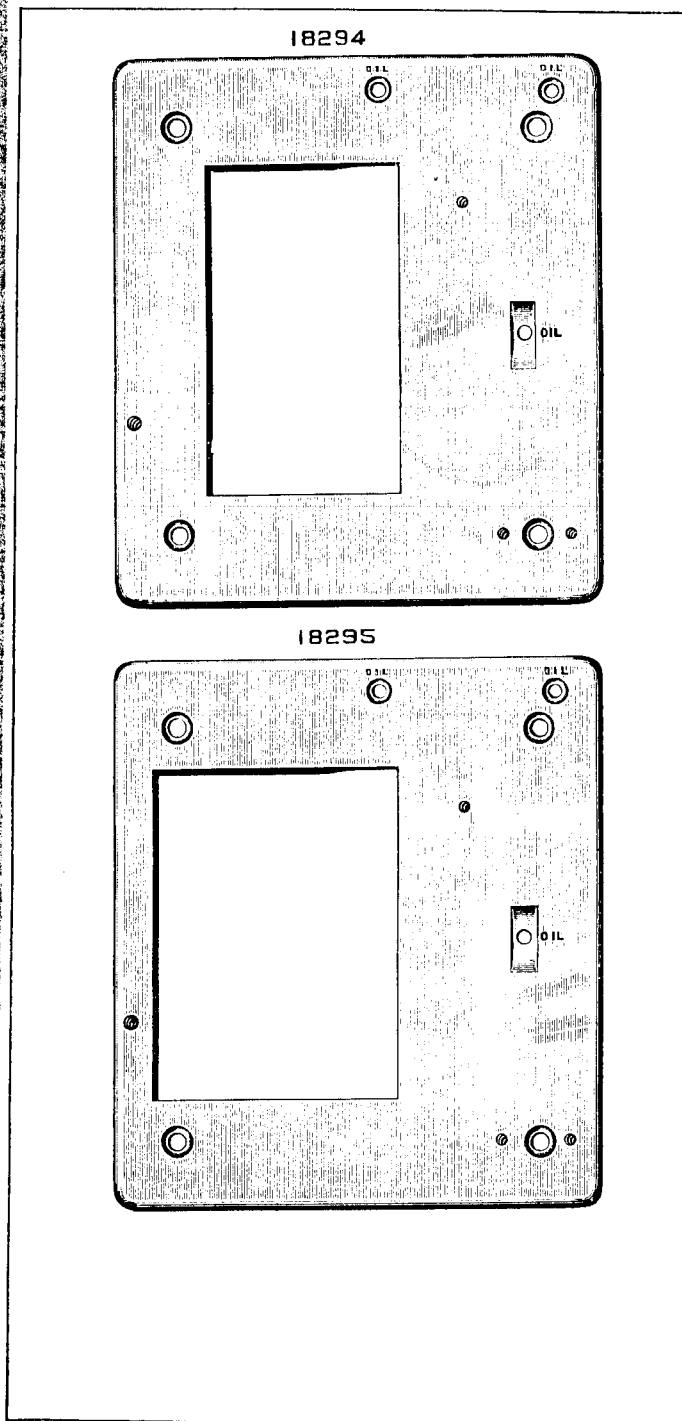


PLATE 5238—FULL SIZE

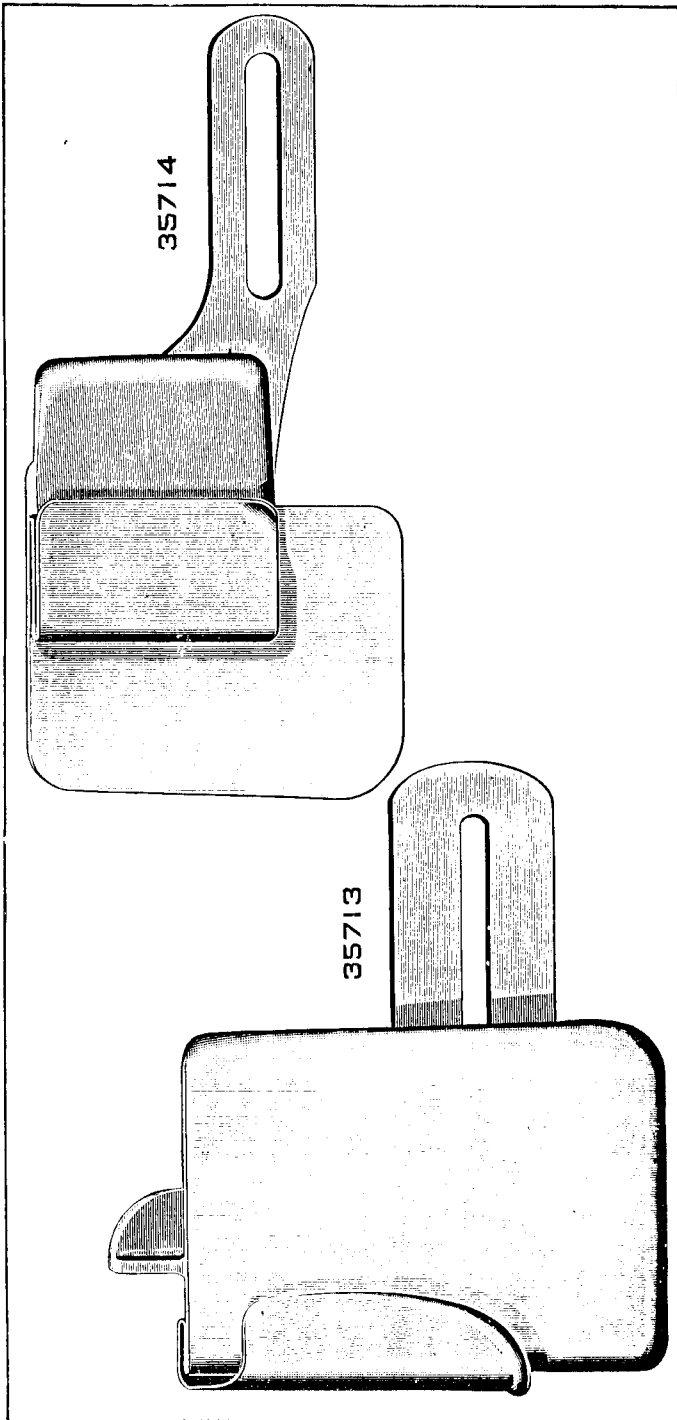


PLATE 5240—ONE-HALF SIZE

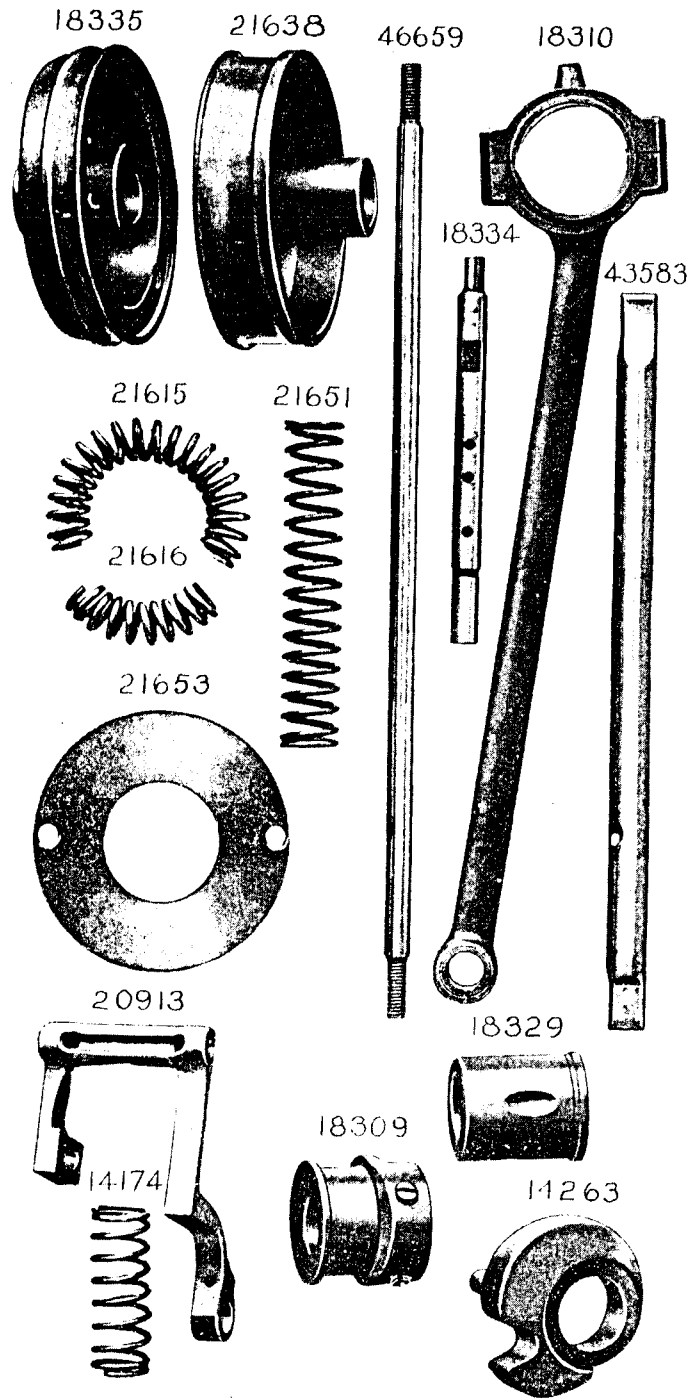
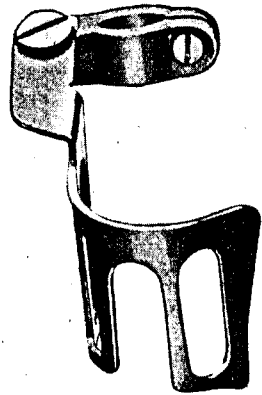
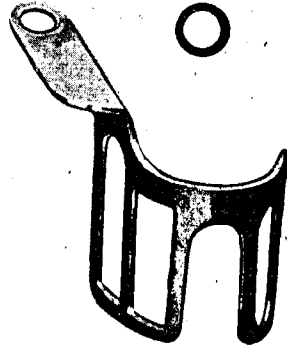


PLATE 5809—FULL SIZE

36821



36818



36819



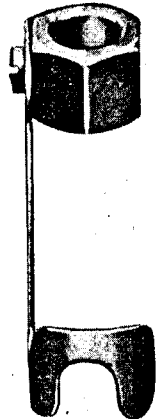
36820



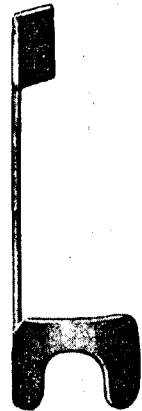
50316 196 50302 236



120498



120496



120497



PLATE 7234—ONE-HALF SIZE

27739



225390

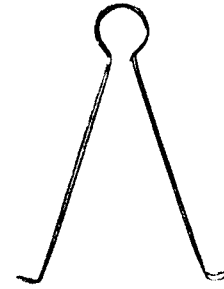


PLATE 22162 FULL SIZE

8582



12453



12454



52045



132590



210



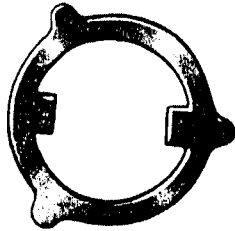
51224



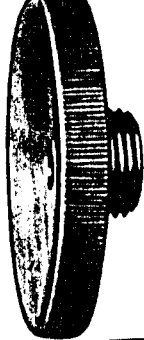
435



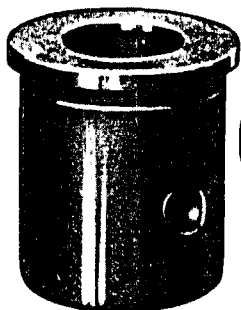
2020



256



12357



12480

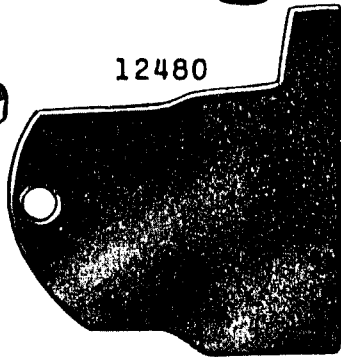


PLATE 22163 ONE-FOURTH SIZE

18328



18131



18145



18276

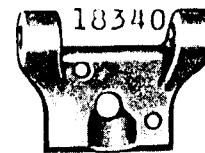


18152



20927

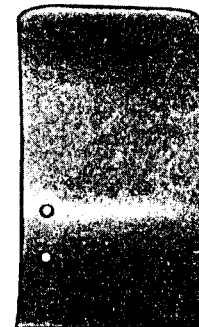
18340



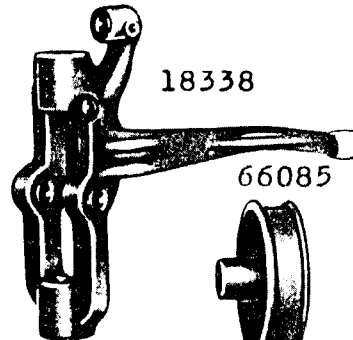
12237



18498



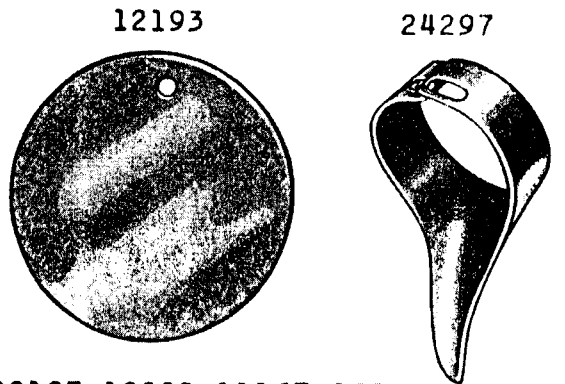
18338



66085



PLATE 22164 ONE-HALF SIZE



20197 18098 11167 12139 20023

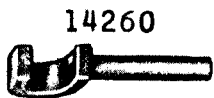
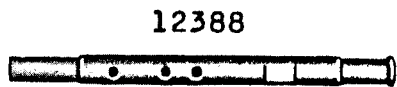
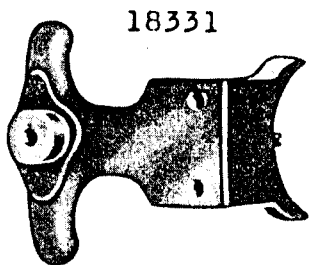
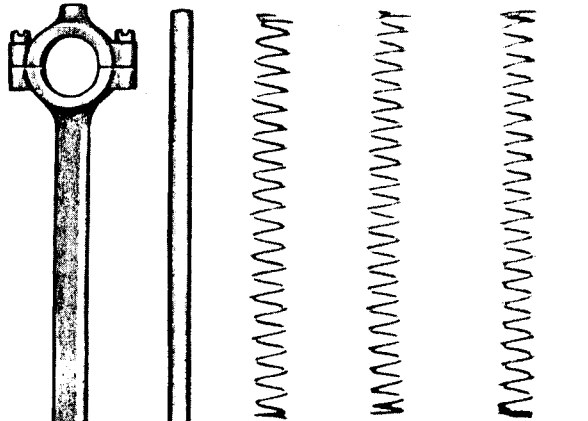
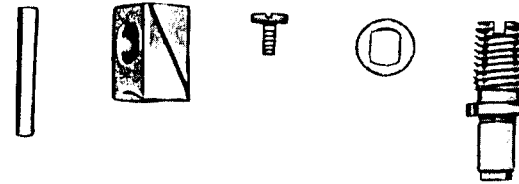


PLATE 22165 FULL SIZE

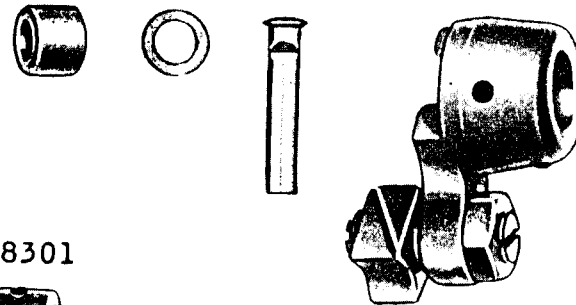
176 898 7071 1389 1120



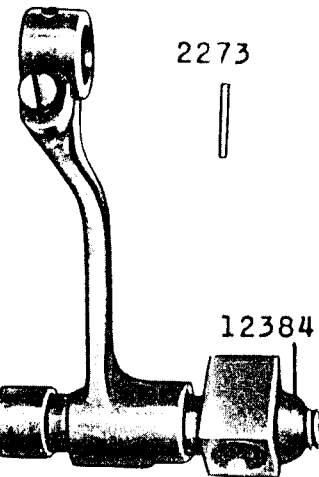
2049 19448 226 12424 988



1904 20910 18344 19447



18301



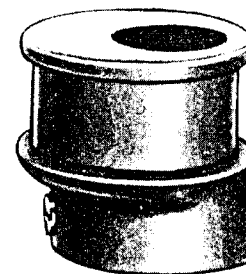
2273



209



5570



12384

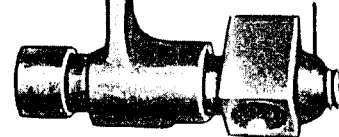
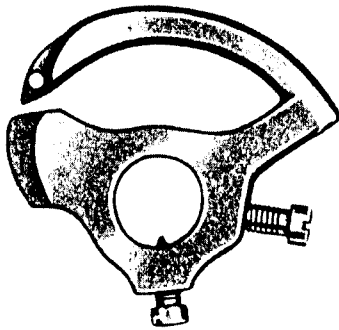


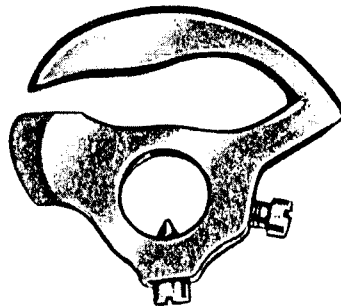


PLATE 22166 FULL SIZE

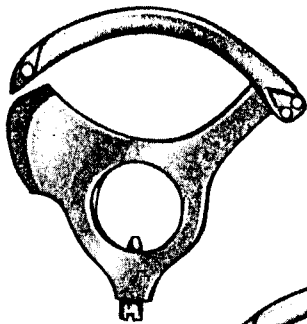
18299



18300



18119



18120

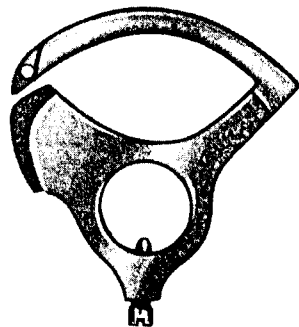
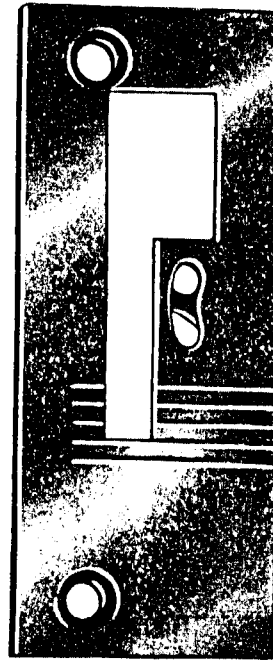
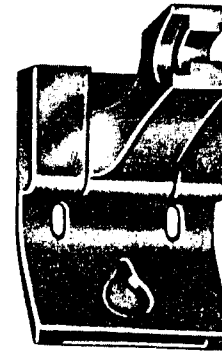


PLATE 22167 FULL SIZE

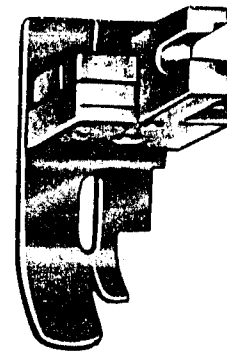
18298



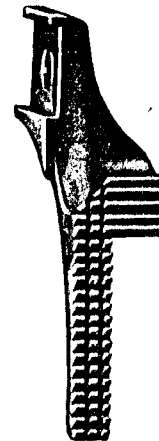
18197



20925



20916



120371

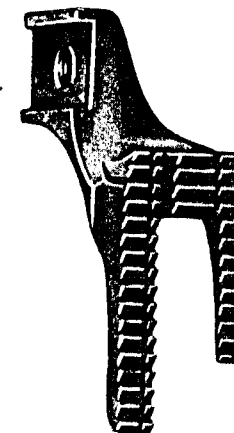
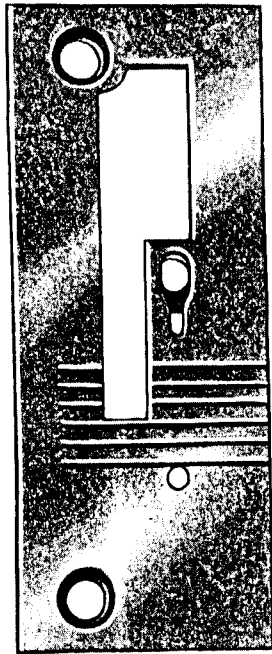
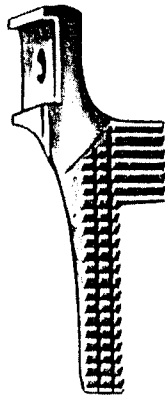


PLATE 22168 FULL SIZE

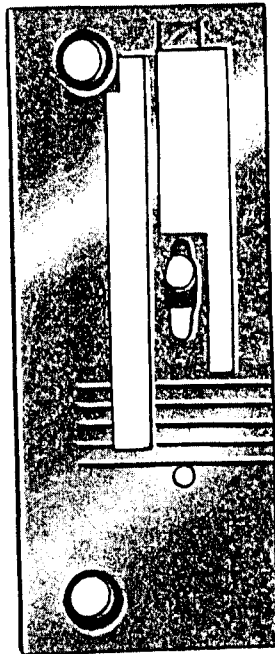
18342



18332



120376

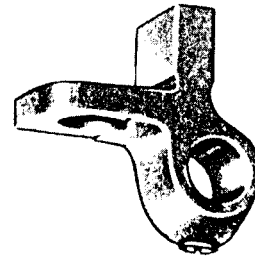


18306

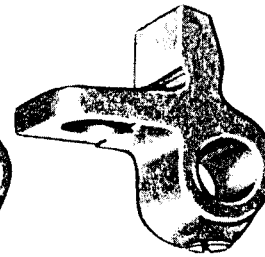


PLATE 22169 FULL SIZE

11168



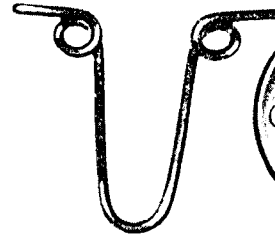
20926



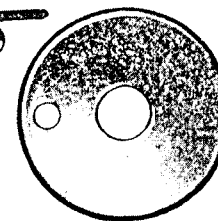
18343



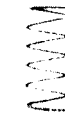
18283



13550



18349



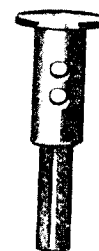
106



23868



18312



43585



23668



7311



62527



56865

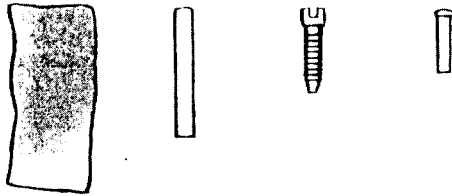


21645



PLATE 22170 FULL SIZE

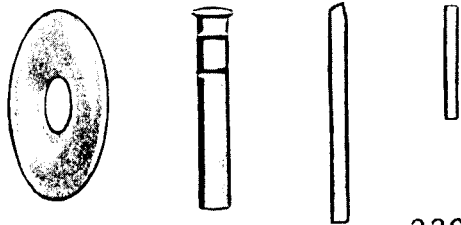
4784 18325 1076 20995



12459 11170 1560 8238



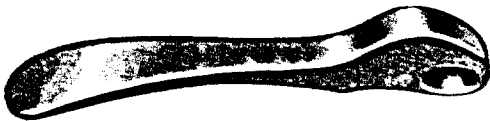
2102 18346 18280 18055



220



52016



5990

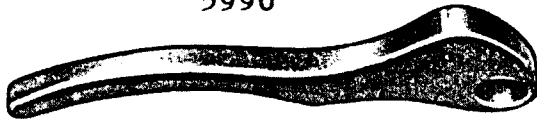
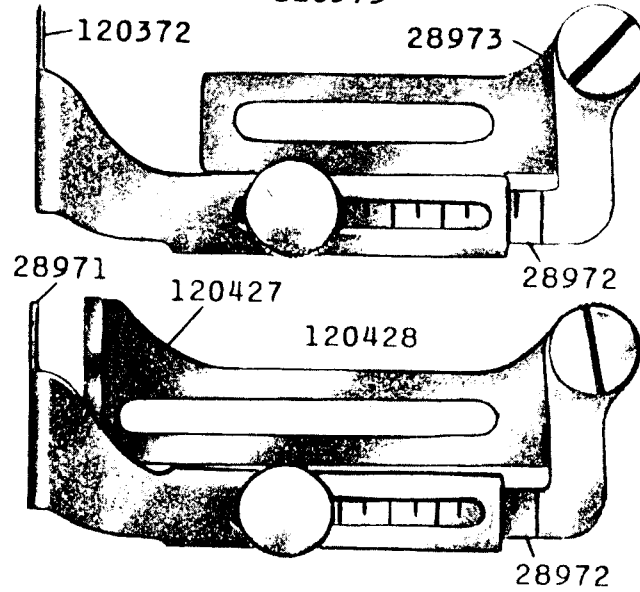
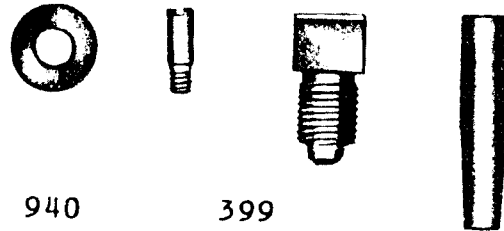


PLATE 22171 FULL SIZE

120373



35610 184 1070 21652



940



399



18341



21617



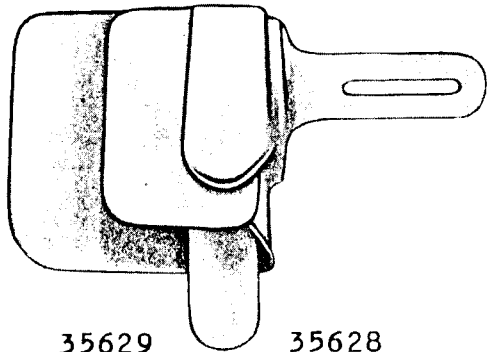
14277



From the library of: Diamond Needle Corp

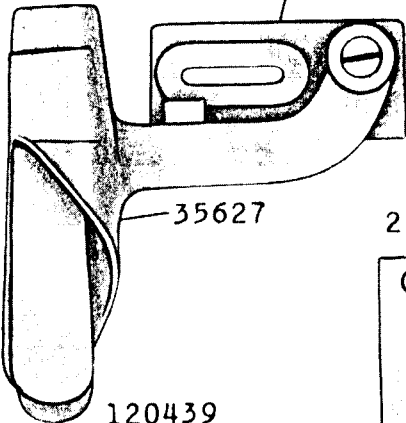
PLATE 22172 ONE-HALF SIZE

35630



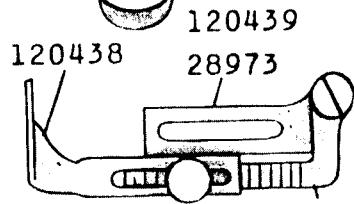
35629

35628



35627

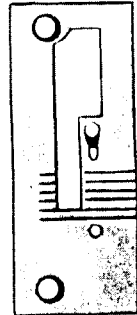
20917



120438

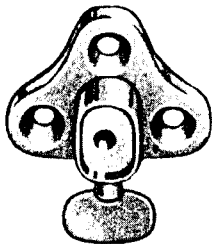
120439

28973



28972

26064



26325

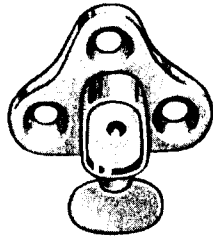


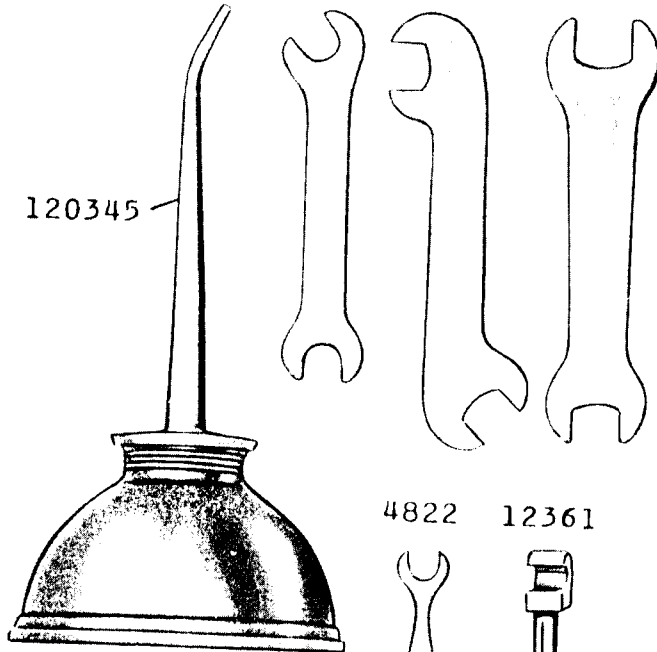
PLATE 22173 ONE-HALF SIZE

120344

8908

19221

8909



120345

4822

12361

26026

26485

41400

120341

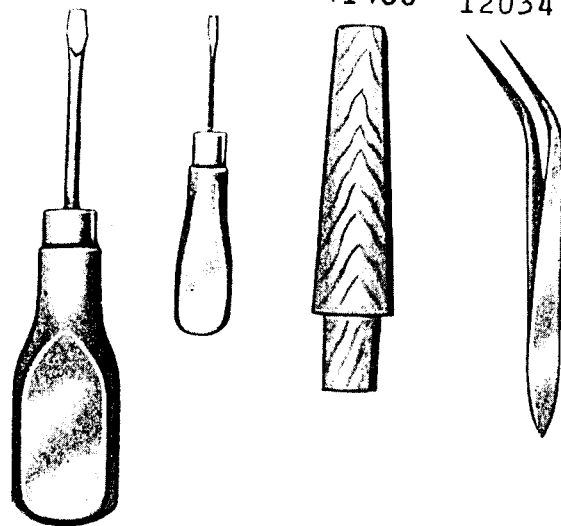
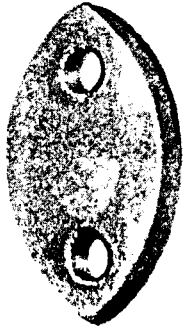


PLATE 22174 FULL SIZE

19219



19220



158



19226



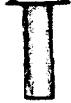
19397



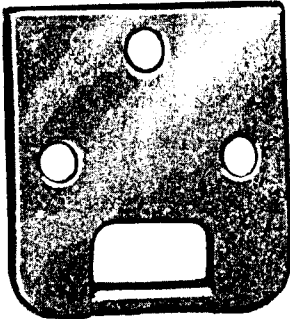
211



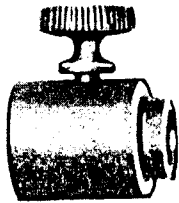
14010



16555



26073



13211



200383



225326



201696



225322



201018

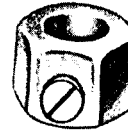


PLATE 22175 FULL SIZE

120496



120497



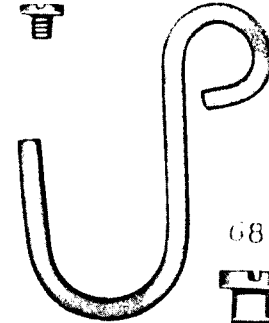
50302



236



56864



178



5601



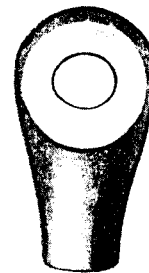
689



12240



12416



5735



140219



From the library of: Diamond Needle Corp

PLATE 22176 ONE-FOURTH SIZE

139637

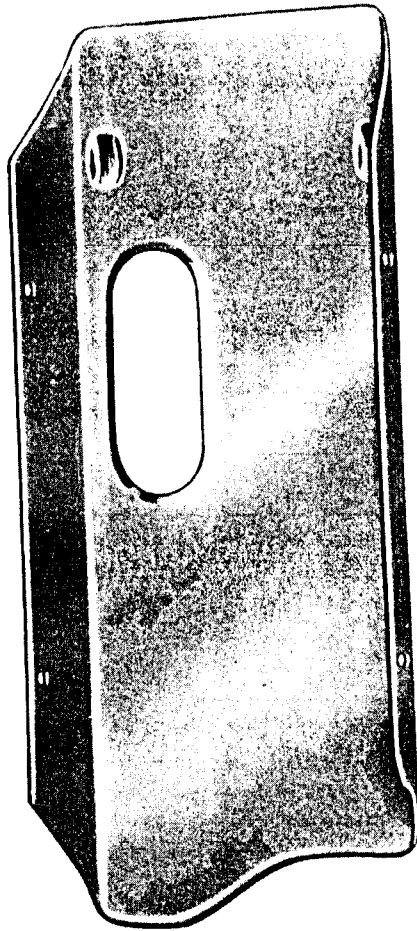
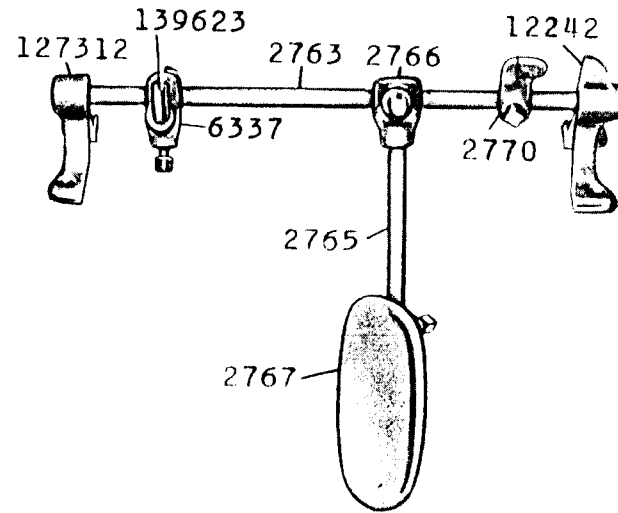


PLATE 22177 ONE-FOURTH SIZE

139624



139625

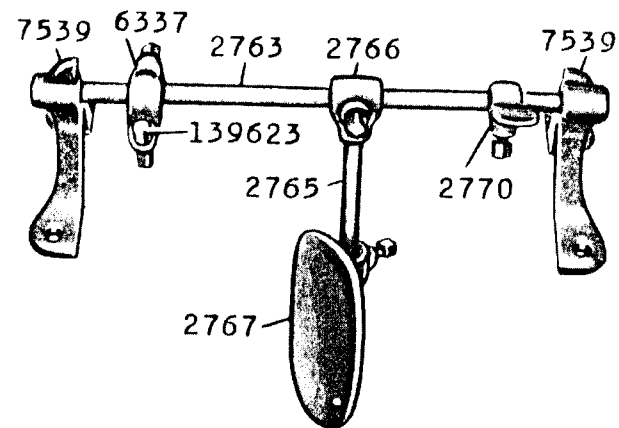


PLATE 22178 ONE-SIXTH SIZE

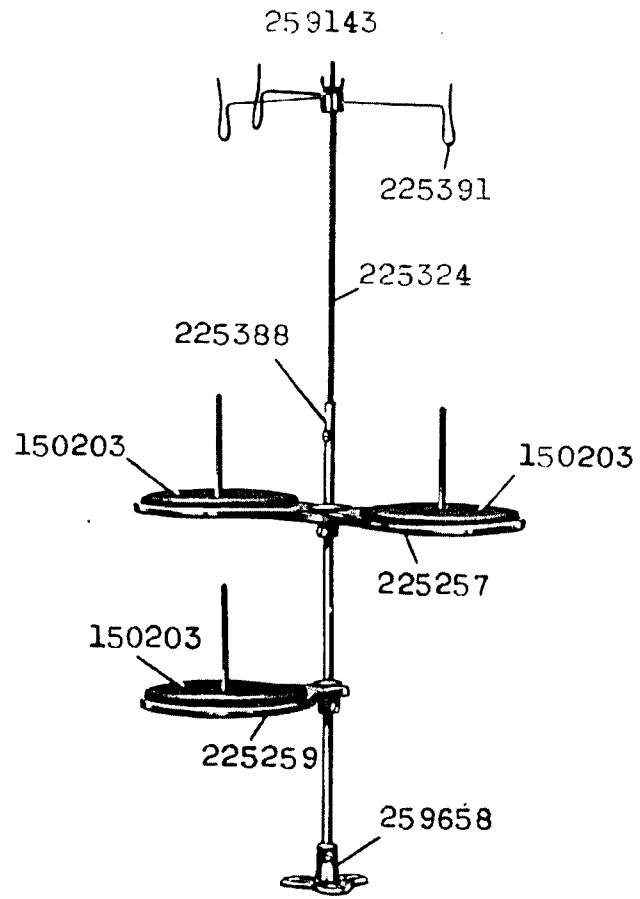
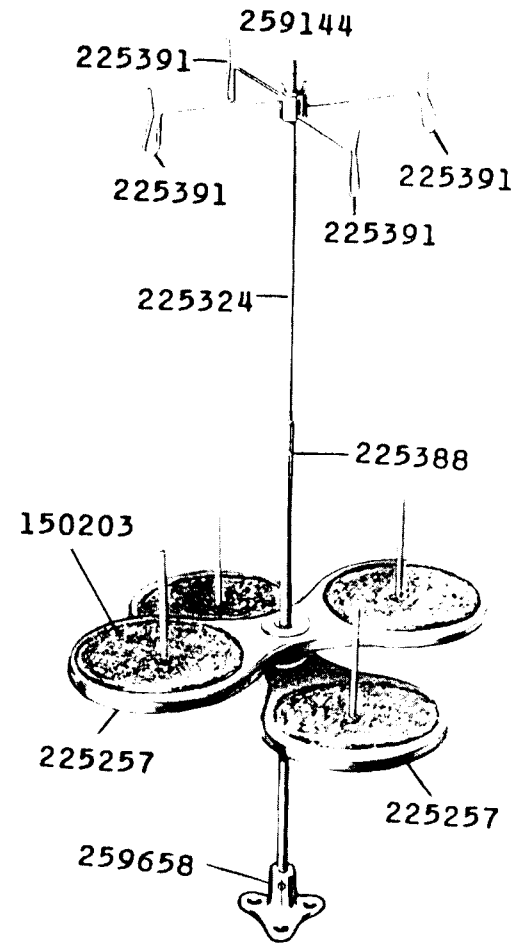


PLATE 22179 ONE-SIXTH SIZE



From the library of: Diamond Needle Corp

PLATE 22180 ONE-SIXTH SIZE

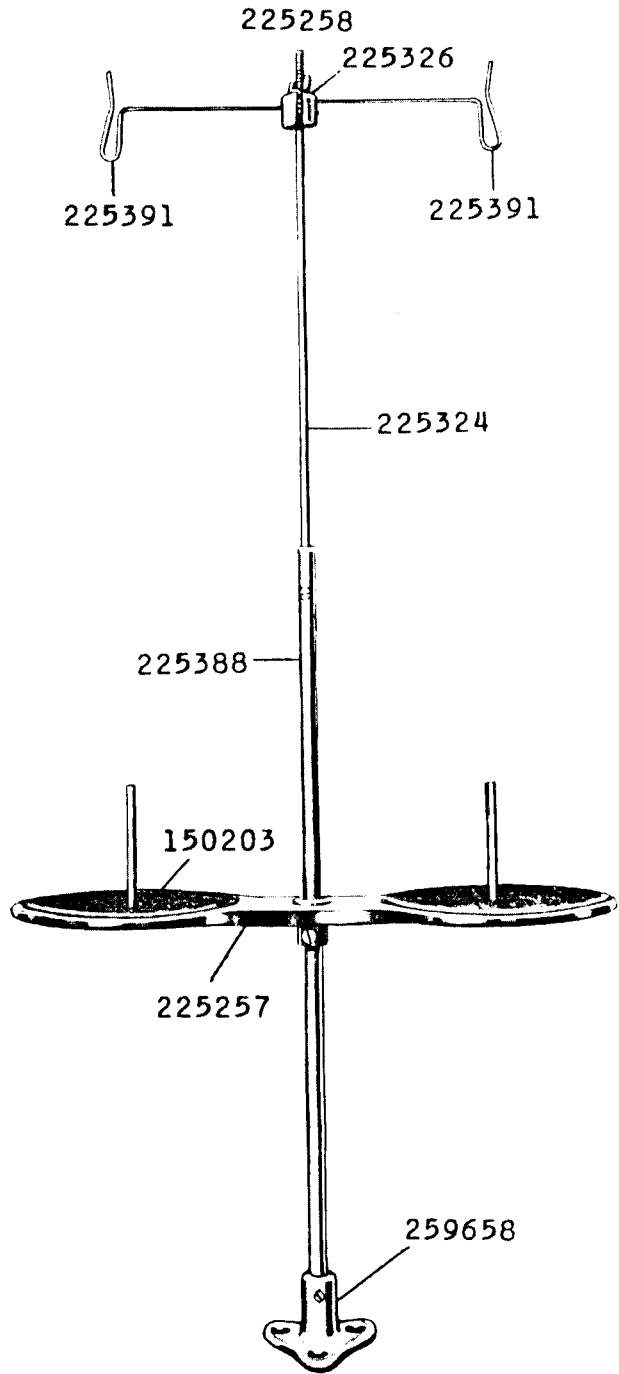
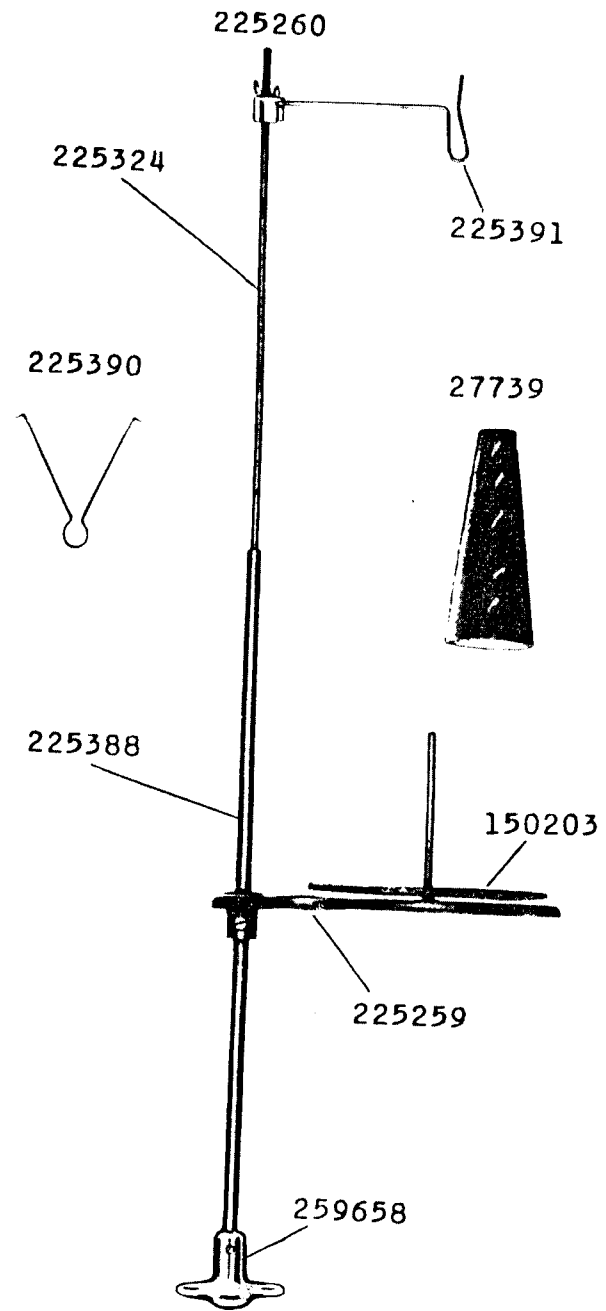


PLATE 22181 ONE-FOURTH SIZE



From the library of: Diamond Needle Corp